

## UNIT I

### PRINCIPLES OF SOLAR RADIATION

**Renewable energy** is generally defined as energy that comes from resources which are naturally replenished on a human timescale such as sunlight, wind, rain, tides, waves and geothermal heat. Renewable energy replaces conventional fuels in four distinct areas: electricity generation, hot water/space heating, motor fuels, and rural (off-grid) energy services. Renewable energy is derived from natural processes that are replenished constantly. In its various forms, it derives directly from the sun, or from heat generated deep within the earth. Included in the definition is electricity and heat generated from solar, wind, ocean, hydropower, biomass, geothermal resources, and biofuels and hydrogen derived from renewable resources.

#### Introduction:

The sun is the source of energy that drives the cycle of life and death on earth. It is also the energy source that gives us warmth and evaporates water and melts snow. The sun is about 150,000,000 km away from the Earth. Due to its immense, but finite size, it has an angular diameter of 0.5 degree (32 minutes), as viewed from Earth. Sun burns continuously via thermonuclear reactions (fusion). Inside the sun, radioactive processes release energy and convection transfers solar energy to its exterior surface. Despite the extremely high temperatures needed at the core of the sun, to sustain its thermonuclear reactions, the sun has a black body temperature of 5770 K. Consequently, we receive a relatively constant flux density of energy, defined as the Solar Constant. Its mean value is  $1366 \text{ Wm}^{-2}$ .

The earth receives  $1.6 \times 10^{18}$  units of energy from the Sun annually, which is 20,000 times the requirement of mankind on the earth. Some of the solar energy causes evaporation of water, leading to rains and creation of rivers etc. Some of it is utilized in photosynthesis which is essential for sustenance of life on earth. Man has tried, from time immemorial, to harness this infinite source of energy, but has been able to tap only a negligibly small fraction of this energy.

When light travels from outer space to earth, solar energy is lost because of following reasons:

1. Scattering: The rays collide with particles present in atmosphere
2. Absorption: Because of water vapor there is absorption
3. Cloud cover: The light rays are diffused because of clouds.
4. Reflection: When the light rays hit the mountains present on the earth surface there is reflection.
5. Climate: Latitude of the location, day (time in the year) also affects the amount of solar energy received by the place. Solar Radiation geometry

In Solar Radiation geometry the following terms are important:

1. Horizon is the horizontal plane that extends from the point where the observer is standing, to infinity, straight through space. Since we're only working with relatively short distances (compared to the Universe), a line extending N-S will be quite sufficient
2. Altitude (A) is the angle of the sun over the horizon. In this problem, we will be working with the sun at noon, so it will either be over the N or S horizon.
3. Zenith (Z) is the angle that the sun is from directly overhead, and it is equal to  $90 - A$ . It, too, can be over the S or N horizon, but there is little need to state it.
4. Declination (D) is the latitude at which the sun is directly overhead. It is always between  $23.5^\circ$  N and  $23.5^\circ$  latitude, those occurring on the Solstices.
5. Latitude (L) is the location N or S of the equator at which the observer is located. (It is determined by radii from the centre of Earth at different angles to the equator. If such an angle is swept along the surface of the planet, it draws a circle.)

### **Instruments for measurement of solar radiation**

A pyranometer is a device used to measure global solar radiation, while a pyrheliometer measures direct radiation. A pyranometer is comprised of a thermopile sensor with a black coating, which absorbs all solar radiation, and a glass dome, which limits the spectral response of the thermopile. A pyrheliometer works similarly, but is designed with a solar tracker to keep the device directly aimed at the sun for the duration of the measurement being taken.

### **Solar Radiation data**

Solar radiation data is necessary for calculating cooling load for buildings, prediction of local air temperature and for the estimating power that can be generated from photovoltaic cells. Solar radiation falling on the surface of the earth is measured by instruments called pyranometers. The weather service in most countries has many stations to measure solar radiation using pyranometers. In India pyranometers have been used for a long time.

### **Energy Scenario Introduction**

Any physical activity in this world, whether carried out by human beings or by nature, is caused due to flow of energy in one form or the other. The word 'energy' itself is derived from the Greek word 'enrgon', which means 'in-work' or 'work content'. The work output depends on the energy input.

Energy is one of the major inputs for the economic development of any country. In the case of the developing countries, the energy sector assumes a critical importance in view of the ever-increasing energy needs requiring huge investments to meet them.

**Energy can be classified into several types based on the following criteria:**

- Primary and Secondary energy
- Commercial and Non commercial energy
- Renewable and Non-Renewable energy
- Conventional and Non-conventional energy

### 1.1 Primary and Secondary Energy

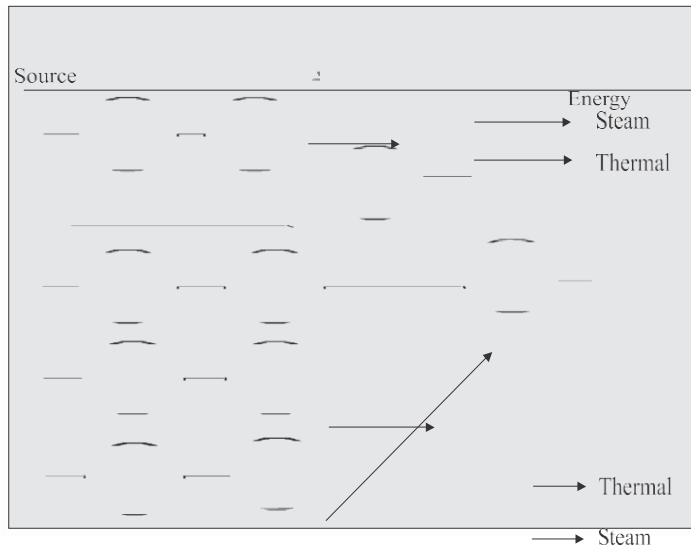

Fig1.1. Major Primary and Secondary sources

Primary energy sources are those that are either found or stored in nature. Common primary energy sources are coal, oil, natural gas, and biomass (such as wood). Other primary energy sources available include nuclear energy from radioactive substances, thermal energy stored in earth's interior, and potential energy due to earth's gravity. The major primary and secondary energy sources are shown in Figure 1.1

Primary energy sources are costly converted in industrial utilities into secondary energy sources; for example coal, oil or gas converted into steam and electricity. Primary energy can also be used directly. Some energy sources have non energy uses, for example coal or natural gas can be used as a feedstock in fertilizer plants.

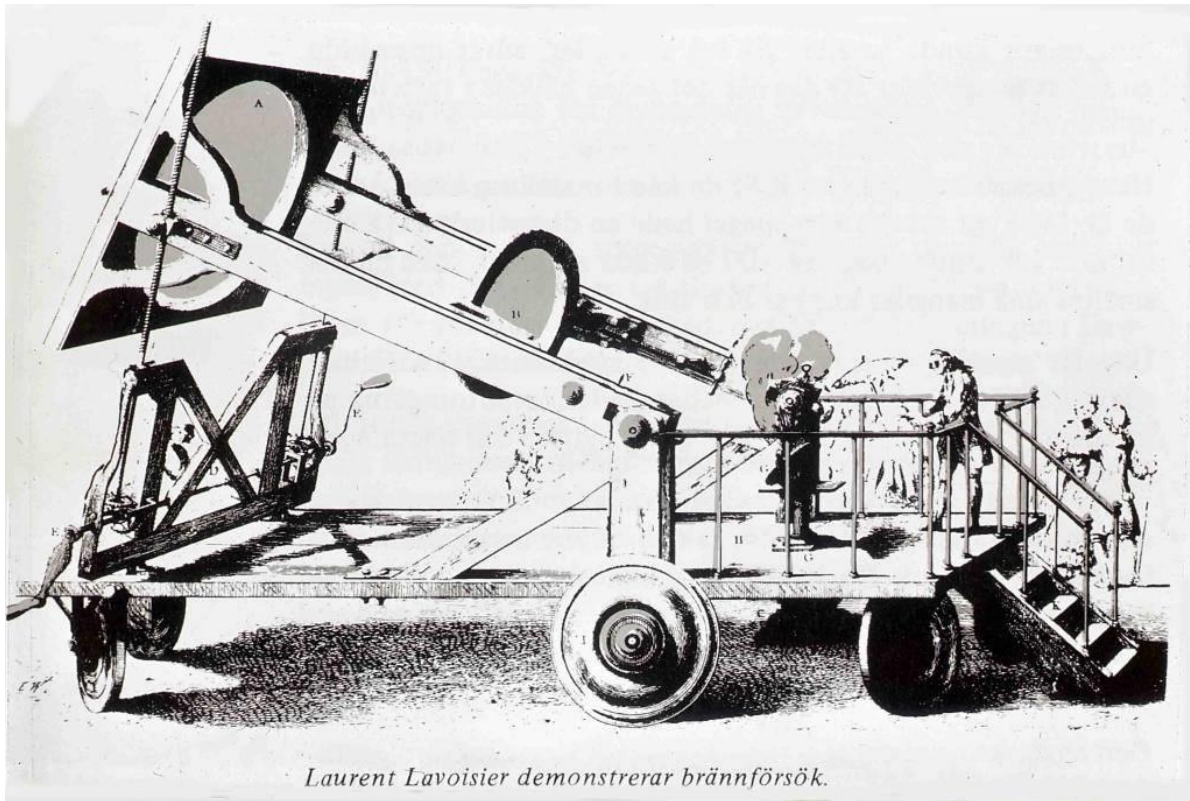

Fig : The French chemist Lavoisier experimented with concentrating solar energy using a large parabolic mirror.

Auguste Mouchout, inventor of the first active solar motor, questioned the widespread belief that the fossil fuels powering the Industrial Revolution in the 19th century would never run out. Prophetically he said: Eventually industry will no longer find in Europe the resources to satisfy its prodigious expansion. Coal will undoubtedly be used up. What will industry do then?

In 1861, Mouchout developed a steam engine powered entirely by the sun. But its high costs coupled with the falling price of English coal doomed his invention to become a footnote in energy history. Nevertheless, solar energy continued to intrigue and attract European scientists through the 19th century. Scientists developed large cone-shaped collectors that could boil ammonia to perform work like locomotion and refrigeration. France and England briefly hoped that solar energy could power their growing operations in the sunny colonies of Africa and East Asia.

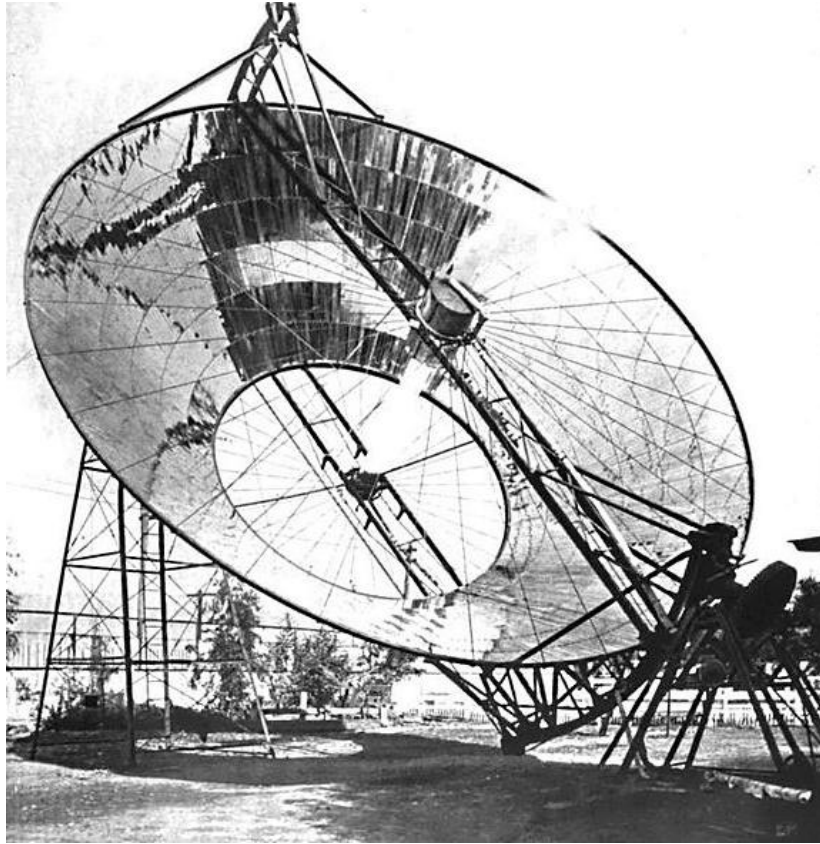

Fig. : 1901 "solar motor" in operation in California.

The solar furnace in Mont Louis, built in 1949 by Professor Félix Trombe, was the first solar furnace in the world. This dual reflection solar furnace has been in steady evolution over the past 50 years and in 1993, was taken over by the limited liability company "Solar Furnace Development" who, along with continued scientific research, is the first company to use a solar furnace for industrial and manufactured products such as the firing of ceramics, and bronze and aluminium products.

Professor Trombelater (1969-1971) directed the design and the construction of the largest solar furnace in the world that we will discuss in detail.



Fig. : The solar furnace in Mont Louis.

### Sun power in the Pyrenees:

In 1972 Time magazine's Science section described the world's largest solar furnace in sufficient technical detail to allow the setting for an investigation that involves a great deal of students' knowledge of physics and, with some guidance, can lead to her asking a series of questions that lead to problems and experimentation that go beyond the textbook. These questions eventually lead to the discussion radiation, optics, wave motion, thermodynamics, solar energy, quantum mechanics and thermonuclear reactions. It should also be mentioned that the Mont-Louis solar furnace in the Pyrenees is still the largest in the world.



Fig. : The Solar Furnace of Odeillo in the French Pyrenees.

Perched high in the Pyrenees, France's powerful new solar furnace (1970) harnesses the almost limitless energy of the sun. Eight stories tall, the furnace's gleaming reflector dwarfs the ancient buildings near by and turns the surrounding hillsides topsy-turvy on its curved surface. Lined up in tiers on a pasture in front of the big reflector stand 63 smaller mobile mirrors. These heliostats, as they are called, can be individually adjusted so that each one reflects the sun's rays directly into the big parabola, thereby creating striking flare-ups of light. Focusing these rays at the oven building only a short distance from its base, the giant mirror concentrates the sun's radiation on the small target area. The converged beams, which are no wider than a foot at their target, can create temperatures as high as  $6,300^{\circ}\text{F}$  ( $3500^{\circ}\text{C}$ ).

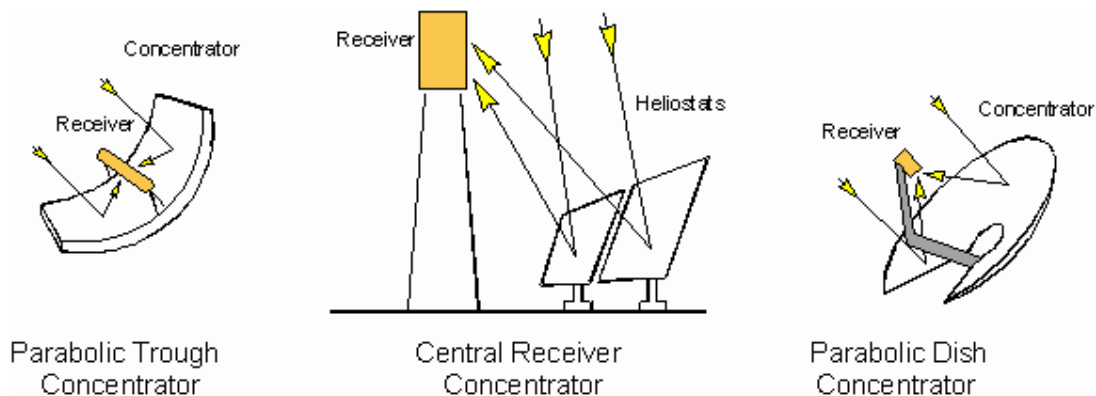

Fig. : Three commonly used reflecting schemes for concentrating solar energy to attain high temperatures.

The description of this context is based on an article in Time magazine's Science section that appeared in the May 18, 1970 issue. The Time article describes the world's largest (1970) solar furnace in sufficient detail for an investigation that involves a great deal of the young physics student's knowledge of physics. The situations described below move from the practical aspects of the furnace to a discussion of geometric optics, radiation, quantum theory, and thermonuclear reactions. The following is the content of the article as it was given in Time magazine.

A simple magnifying glass, focusing the sun's rays, can scorch a piece of wood or set a scrap of paper on fire. Solar radiation can also be concentrated on a much more awesome scale. It can burn a hole through thick steel plate, for example, or simulate the thermal shock of a nuclear blast. It can, that is, with the aid of a super reflector of the sort that has been set up by French scientists high in the Pyrenees. Ten years in the building, the world's largest solar furnace is a complex of nearly 20,000 mirrors and can concentrate enough sunlight to create temperatures in excess of 6,000° F, or 3500°C.

Harnessing solar energy is hardly a new accomplishment. Nearly 22 centuries ago, the Greek mathematician Archimedes is said to have temporarily saved Syracuse from Roman conquest by setting the invading fleet aflame with numerous large mirrors. In the 18<sup>th</sup> century, the pioneer French chemist Lavoisier produced enough heat with 52-inch-wide lenses to power his experiments. Though Lavoisier's work was cut short by the French Revolution (he was guillotined in 1794), his history has not discouraged contemporary French scientists—notably Physical Chemist Felix Trombe, a research director of France's National Center for Scientific Research and its premier experimenter with the sun's energy.

For more than 20 years, Trombe has championed solar furnaces as an ideal source of intensive heat for both industrial uses and scientific experimentation. In 1946 he fashioned his first sun stove out of a captured German anti-aircraft searchlight mirror at an observatory near Paris. Moving to the old Pyrenean citadel town of Mont-Louis where the sun shines as many as 200 days a year, he has since built five larger solar furnaces. Now, in masterly style, he has created his *pièce de résistance* on a hillside in the nearby ski resort of Odeillo. Compared with similar devices in several other countries, such as the U.S. Army's 30-kilowatt stove at Natick, Mass., Odeillo's 1,000-kilowatt structure is easily the Mount Palomar of solar furnaces.



Fig: The Solar Furnace of Odeillo; the parabolic shape of the giant solar collector is evident here.



Fig: The array of mirrors is controlled by a computer and turn with the sun.



Fig : The array of solar collector and the mirrors in perspective.

### **Delicate Adjustment (A report from the early 1970s)**

The furnace's appearance is as spectacular as its power. Its glittering eight-story-high parabolic reflector (roughly half the size of a football field) towers over Odell's centuries old houses. Anchored against a reinforced concrete office and laboratory building, the huge concave mirror consists of 8,570 individual reflectors. For the furnace to operate efficiently, these small (18 inches square, or 46 cm square) mirrors must be precisely adjusted so that their light will converge at the parabola's focal point 59 ft (18.0 m) in front of the giant reflector. Only half of the mirrors have been aligned thus far, although the structure has been finished for more than year. Reason: the work is so delicate that technicians can usually adjust no more than a few dozen even on the sunniest of days. The "focal point" is actually about 0.10 m<sup>2</sup>. Far too huge to follow the sun itself, the parabolic reflector depends on the help of 63 smaller mirrors set in eight rows on a terraced slope in front of it. Called heliostats (from the Greek *helios*, sun; *statos*, to cause to stand still), they track the solar disk across the sky, capture its light and bounce it in parallel beams into the big mirror. The system involves some ingenious engineering. Each heliostat is controlled by its own photoelectric cells.

Whenever one of the heliostats (each of which is made of 180 individual mirrors) loses its lock on the sun, these tiny electric eyes inform a minicomputer, which in turn controls a pair of hydraulic pumps that can rotate and tilt the heliostat into the proper position. Only one manual adjustment is needed to operate the



heliostats. It is made at the end of the day, when they must be reset to face the position of the next day's sunrise.

### **Rotating Vats:**

The crucible of the furnace is located inside a smaller T-shaped building near the base of the big mirror (See Fig). It is set behind large stainless-steel doors at the focal point of the parabola—where the sun's scorching rays are concentrated into a blazing circle only twelve inches wide. Target material, hoisted into place by a ten-ton lift, is placed into an inclined trough; as the target melts, it runs off into catch pans. Another, more sophisticated technique is to load the material into two aluminum vats whose outer walls are water-cooled to prevent melting. Placed with their open ends at the focal point and rotated like washingmachines to distribute the heat evenly, these containers can hold up to 2¾ tons of moltenmaterial at one time (See Fig. ).

Is all this elaborate effort worth the French government's \$2,000,000 (in 1970 currency)investment in the furnace? Professor Trombe says so. For one thing, the power is almostentirely free (only 13 kilowatts of electric power is needed to operate the mirrors). Moreimportant, the furnace gives off what he calls "aristocratic" or uncontaminated heat; there is,for example, none of the adulterating carbon that is produced by the hot electrodes in ordinaryhigh-intensity electric arc furnaces. Thus the solar oven is ideal for the production ofchemically pure materialsFrench industry is beginning to agree. In a recent test for an electronics manufacturer, thefurnace fused several tons of bauxite and ceramics to produce high-voltage insulators ofmatched purity. The oven could easily fuse other highly heat-resistant materials: quartzcrystals for radio transmitters, corundum for industrial grinding stones and zircon parts fornuclear reactors. It could also be used in experiments to develop new space-age alloys, suchas special tungsten or cobalt steels, and even materials to withstand the searing heat of anuclear blast.

### **Initial Fears:**

Aside from the industrial and scientific benefits, the furnace has produced an entirelyunexpected dividend. At first, Odeillo's villagers thought they might be blinded by the intense light from what they call *le four solaire* (the solar oven). Now they know that thelight is concentrated at only one small area and that there is no such danger. In fact, thevillagers have become quite proud of the strange, shimmering edifice in their midst. And whynot? The solar furnace is not only handsome in an other-worldly way; it is also a significant tourist attraction, bringing thousands of people to gaze in awe at Odeillo's mighty mirror.

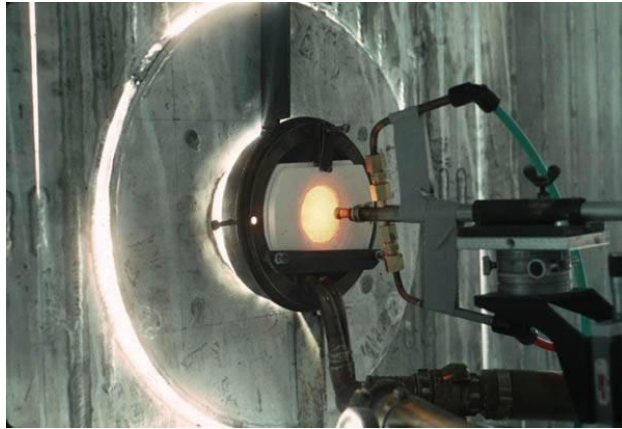

Fig: Beam focus

## **A technical description of the solar furnace**

### 1. Technical details of the heliostats field:

- Weight : 5000 kg with 800 kg of mirrors
- Number of mirror by heliostat : 180 (50 x 50 x 0.75 cm)
- Type of mirror : polished, rear face silver coated
- Dispersion : 1-2 angle minutes
- Reflectivity : 0.79
- Adjustment by autocollimation with a theodolite
- axis movements
- Control command by calculated coordinates
- Precision : 1/60 of degree
- Total reflective area : 2835 m<sup>2</sup>
- Horizontal reflected beam, North South, height 40 m, width 54 m
- Number : 63 placed on 8 terraces
- Surface: 45 m<sup>2</sup> for each heliostat.
- Dimensions : 7.5 m (width) x 6.0 m (height)

### 2. Technical details of the parabolic reflector

- Paraboloid, vertical axis facing north
- Focal length 18 m, height 40 m, width 54 m
- Horizontal focal axis at 13 m from the ground

- Optical aperture  $f/D = 0.3$
- Area 1830 m<sup>2</sup>
- 9130 mirrors (average dimension 48,5 x 48,5 x 0,4 cm)
- Tempered glass, silver coated on the rear face
- Reflectivity 0.79
- Mirrors mechanically bended
- Possible individual adjustment of each mirror

### 3. Technical details of the "focal" tower

- T shape tower, 20 m high
- Shadow: 5% of the paraboloid area
- Control room at the 5th floor north side
- Focal room at the 5th floor south side

### **Absorption of radiant energy by the atmosphere:**

Absorption is mainly caused by three different atmospheric gases. Contrary to popular belief, water vapor causes the most absorption, followed by carbon dioxide and then ozone. In the picture below, one can see how much of the total incoming radiation the atmosphere typically absorbs.

The second way in which absorption helps the earth is as a heat source for it. If one were to take a vertical cross section of the entire atmosphere, one would note that the temperature generally increases with height. This increase in temperature is caused by an increase in absorption of electromagnetic radiation with height due to higher concentrations of high energy wavelength (low wavelength and high frequency) absorbing gases present at higher atmospheric levels.

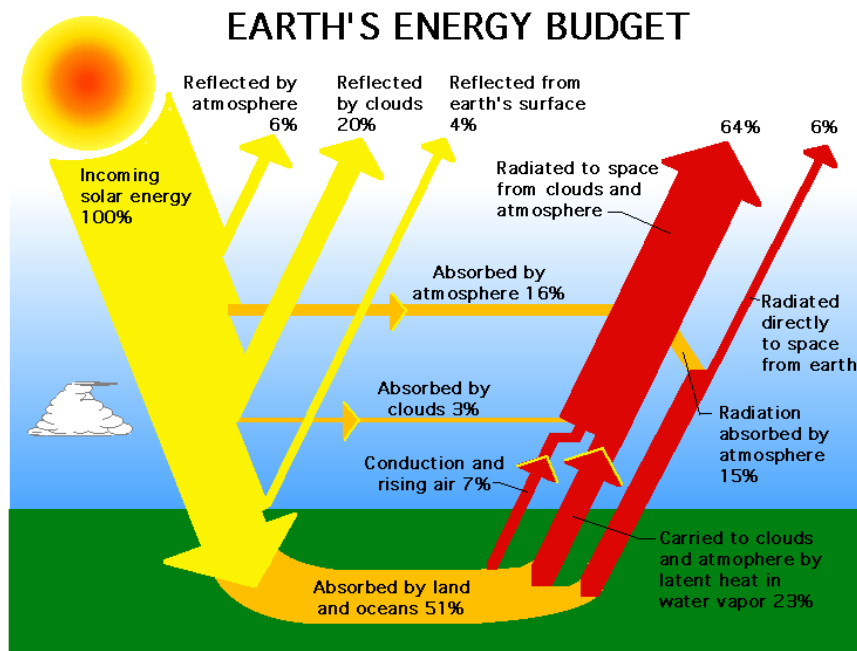

Fig: The Earth Radiation Budget is the balance between incoming energy from the sun and the outgoing longwave(thermal) and reflected *shortwave* energy from the Earth.

Sunlight is *reflected* by surfaces and *absorbed* by gases and surfaces. Greenhouse gases *do not* reflect sunlight. Infrared energy is *emitted* and absorbed by surfaces and greenhouse gases. Radiation refers to radiant energy, not nuclear radiation.

Notice also that the amount of infrared energy emitted at the top of the atmosphere (235 W/m<sup>2</sup>) must equal almost exactly the amount of solar energy absorbed by earth (342–107 W/m<sup>2</sup>). The small difference, about a watt per square meter, leads to global warming or cooling.

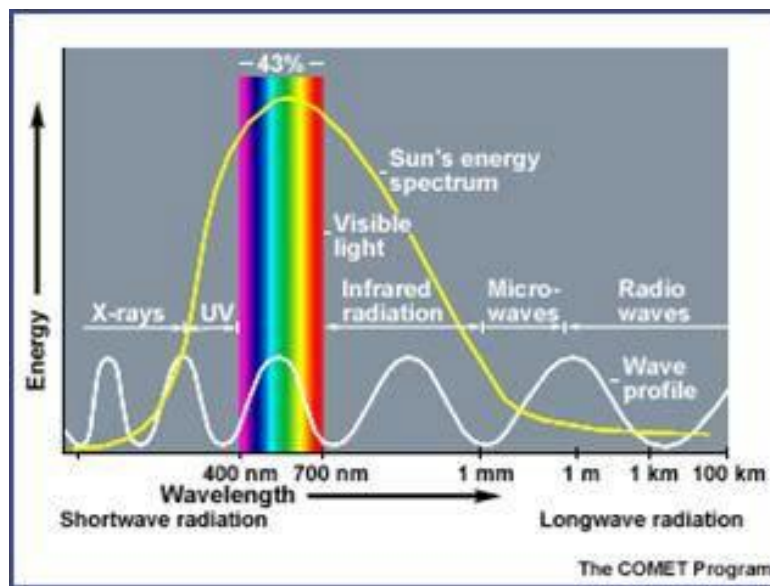

Fig: The solar spectrum.

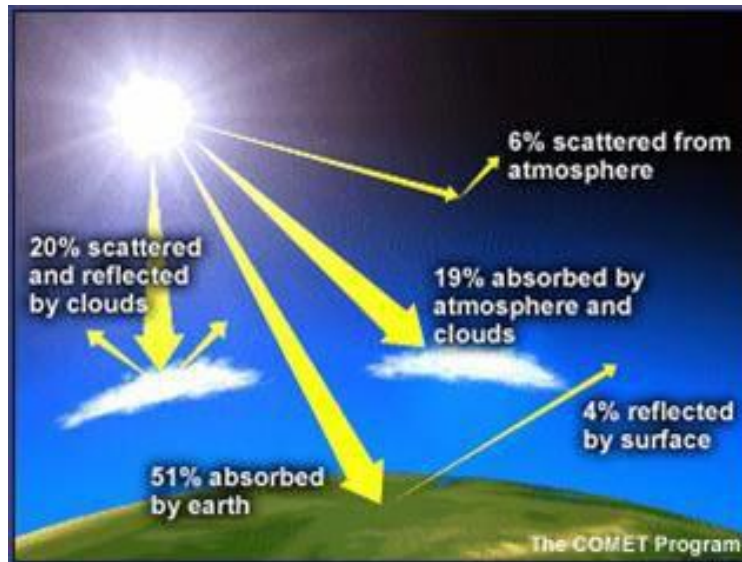

Fig : This figure gives approximate percentages for solar radiation

**Measuring the temperature of a glowing material:**

Physicists and engineers use a pyrometer (see figure 26). The illustration below shows a very simple type of radiation pyrometer. Part of the thermal radiation emitted by a hot object is intercepted by a lens and focused onto a thermopile. The resultant heating of the thermopile causes it to generate an electrical signal (proportional to the thermal radiation) which can be displayed on a recorder.

The optical pyrometer should more strictly be called the disappearing-filament pyrometer. In operation, an image of the target is focused in the plane of a wire that can be heated electrically. A rheostat is used to adjust the current through the wire until the wire blends into the image of the target (equal brightness condition), and the temperature is then read from a calibrated dial on the rheostat. See problem 1 below.

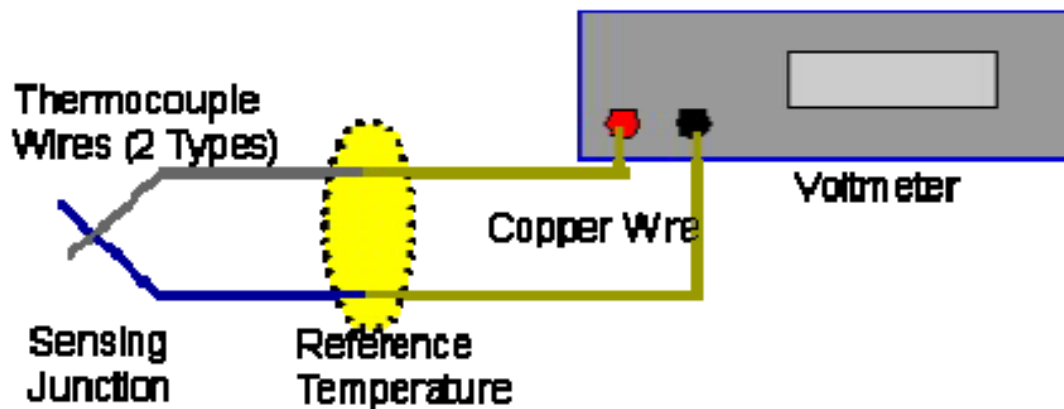

Fig: Thermocouple

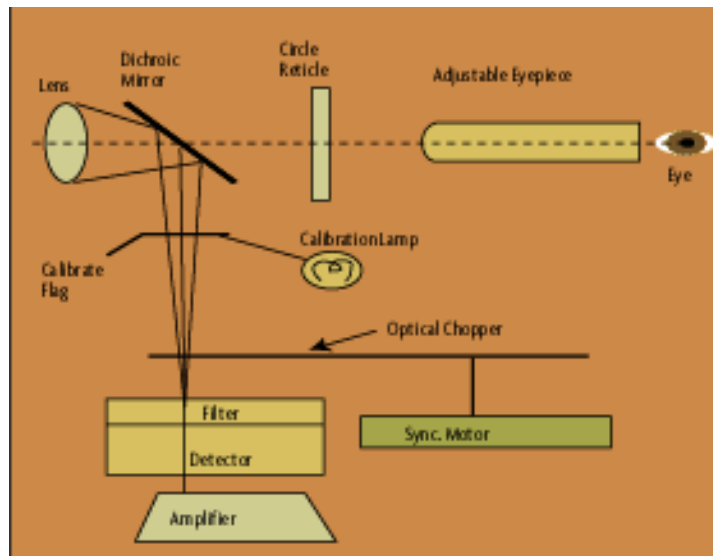

Fig: Automatic optical pyrometer

### The energy output of the sun

We will first discuss how the energy output of the sun can be measured and then show how the surface temperature can be estimated. To estimate the energy output of the sun, we need to know:

1. The distance between the earth and the sun, and
2. The amount of radiant energy the sun provides at the top of the atmosphere (about 100 km from the surface of the earth).

In addition, we must assume that the radiation is given out evenly (isotropic) in all direction. See Fig. below. We could, of course measure the amount of radiation energy the sun provides on the surface of the earth by simply measuring the energy required to heat up an object that is exposed to the sun for a certain time. Unfortunately, we can only guess the amount of solar energy that the atmosphere absorbs or reflects. The distance to the sun was well known already in the 19th century, about  $1.5 \times 10^{11}$  m. We must then know the radiation energy of the sun striking the Earth, or find the value of the *solar constant*

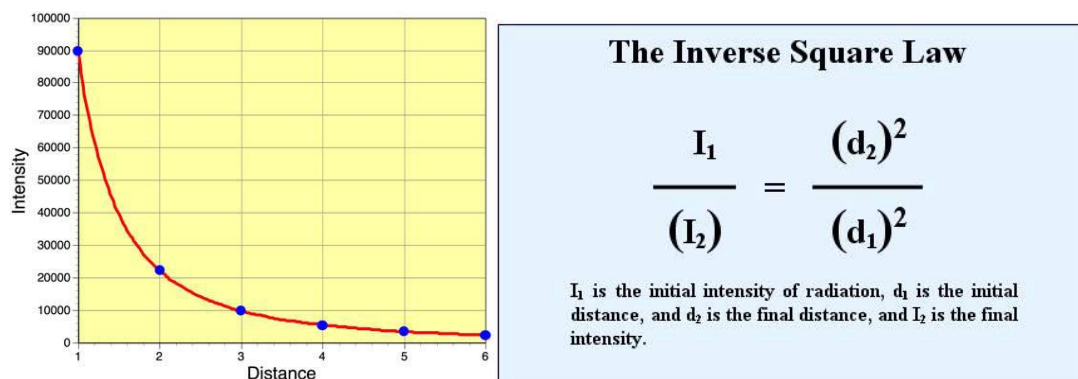

Fig. 27: The inverse square law of radiation, with three representations: visual, graphical and mathematical all showing intensity reduction with distance travelled.

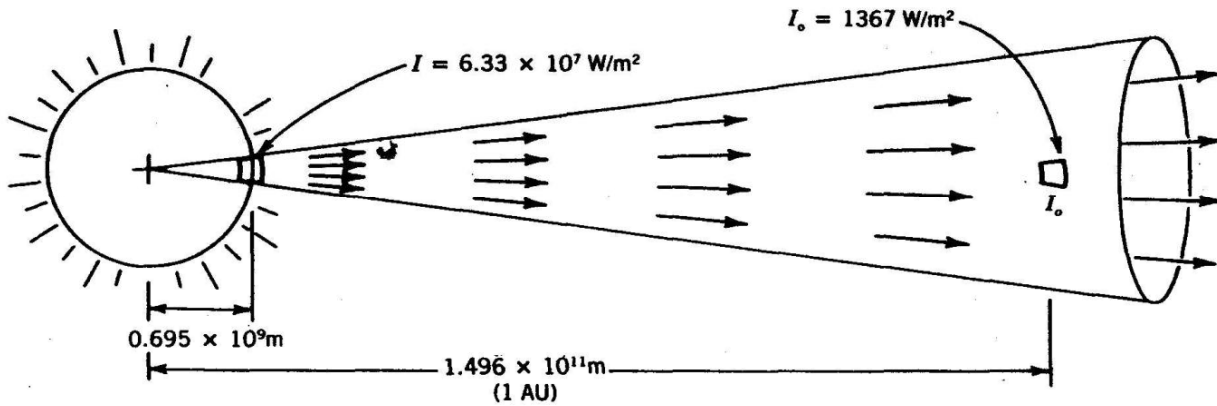

Fig : The inverse square law of radiation from the sun.

### The solar constant and its determination.

The *solar constant* is defined as the amount of heat energy received per second per unit area ( $\text{J/s/m}^2$ , or  $\text{W/m}^2$ ) and completely absorbed by a “perfect black body” at the surface of the Earth with the surface being held perpendicular to the direction of the sun's rays. One instrument used for measuring the solar constant is called Pyroheliometer. In the middle of the 19<sup>th</sup> century, a very good measurement was made by the French physicist Pouillet. Later, the Swedish physicist Angstrom developed an improved version, called a compensationpyro heliometer, is described below.

Various scientists had tried to calculate the Sun's energy output, but the first attempts at a direct measurement were carried out independently and more or less simultaneously by the French physicist Claude Pouillet (1790-1868) and British astronomer John Herschel (1792- 1871). Although they each designed different apparatus, the underlying principles were the same: a known mass of water is exposed to sunlight for a fixed period of time, and the accompanying rise in temperature recorded with a thermometer. The energy input rate from sunlight is then readily calculated, knowing the heat capacity of water. Their inferred value for the solar constant was about half the accepted modern value of  $1367 \pm 4$  Watts per square meter, because they failed to account for of absorption by the Earth's atmosphere.

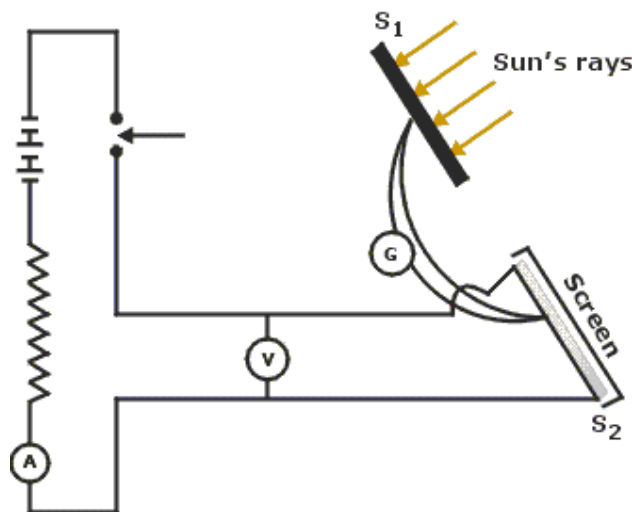

Fig. 30: Angstrom's compensation pyroheliometer

### **The total energy output of the sun.**

We are now ready to estimate the total energy output of the sun, assuming that the inverse square law is applicable. We know the following:

1. The value of the solar constant. We will take it as approximately 1400 W/m<sup>2</sup>.
2. The distance to the sun: approximately 1.5x10<sup>11</sup> m.
3. The inverse square law: The radiation, measured in W/m<sup>2</sup> from a point source (Consider the sun's energy to come from a point source (see Fig. above)) is inversely proportional to the distance from the source squared.
4. The area of the surface of a sphere is  $4\pi r^2$ .

The following then is a guide for solving this problem:

First show that the inverse square law requires that the radiation energy from the sun intercepted by 1 m on the earth's surface is the solar constant, or about 1400 W/m<sup>2</sup>. Secondly, calculate the total energy going through the surface of the giant sphere with a radius of the distance to the sun, namely 1.5x10<sup>11</sup> m. Finally, show that this is equal to about 3.9x10<sup>26</sup> J/s.

This is an enormous amount of energy given out each second. See problem xx for more detail.

### **Determining the temperature of the surface of the sun:**

Having estimated the energy output of the sun to be 3.9x10<sup>26</sup> J/s, it is now possible to estimate the temperature of the surface of the sun. We have already suggested that the temperature of the surface of the sun by a measurement using a pyrometer, or more precisely, a pyro heliometer.

The temperature of the sun is found to be about 6000 K.

However, it is also possible to confirm this value with a theoretical approach by using the physics of black body radiation. See discussion of black body radiation and Fig. xx below. According to the theory of black body radiation, the sun is radiating energy, given by the Stephan-Boltzmann law  $R = \delta A T^4$  (see detail below). R is the radius of the sun, A the area of the surface of the sun,  $\delta$  an experimentally determined constant (  $5.67 \times 10^{-8}$  watts / m<sup>2</sup> x T<sup>4</sup>.), and T the temperature of the surface of the radiating black body object. You can now show that the temperature of the sun, according to this approach, is about 5900 K.

Although the sun is millions of degrees in its core, pyrometric measurement of the surface of the sun produces a black body temperature of about 6000 degrees K and the maximum power wavelength of the black body curve, shown below, is: Wavelength (max) = (0.0029)/T = .0029/6000 = 483 nanometers (nm).

Thus the sun appears white hot because the peak radiation output is in the blue/green portion of the visible spectrum.



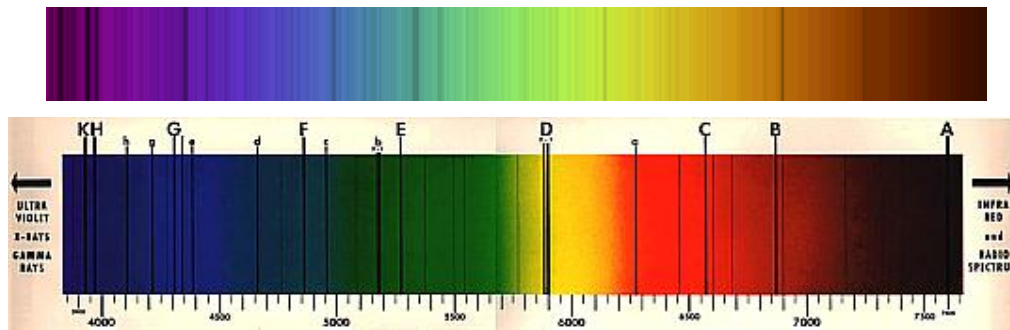

Fig : The Solar Spectrum

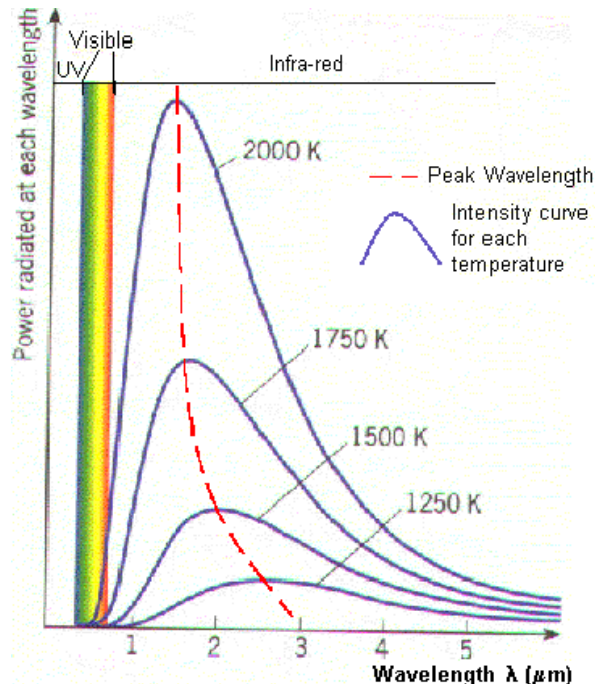

Fig: Black body radiation

### Commercial Energy and Non Commercial Energy:

#### Commercial Energy:

The energy sources that are available in the market for a definite price are known as commercial energy. By far the most important forms of commercial energy are electricity, coal and refined petroleum products. Commercial energy forms the basis of industrial, agricultural, transport and commercial development in the modern world. In the industrialized countries, commercialized fuels are predominant source not only for economic production, but also for many household tasks of general population.

Examples: Electricity, lignite, coal, oil, natural gas etc.

## Non-Commercial Energy:

The energy sources that are not available in the commercial market for a price are classified as non-commercial energy. Non-commercial energy sources include fuels such as firewood, cattle dung and agricultural wastes, which are traditionally gathered, and not bought at a price used especially in rural households. These are also called traditional fuels. Non-commercial energy is often ignored in energy accounting.

Example: Firewood, agro waste in rural areas; solar energy for water heating, electricity generation, for drying grain, fish and fruits; animal power for transport, threshing, lifting water for irrigation, crushing sugarcane; wind energy for lifting water and electricity generation.

## 1.2 Renewable and Non-Renewable Energy

Renewable energy is energy obtained from sources that are essentially inexhaustible. Examples of renewable resources include wind power, solar power, geothermal energy, tidal power and hydroelectric power (See Figure 1.2). The most important feature of renewable energy is that it can be harnessed without the release of harmful pollutants. Non-renewable energy is the conventional fossil fuels such as coal, oil and gas, which are likely to deplete with time.

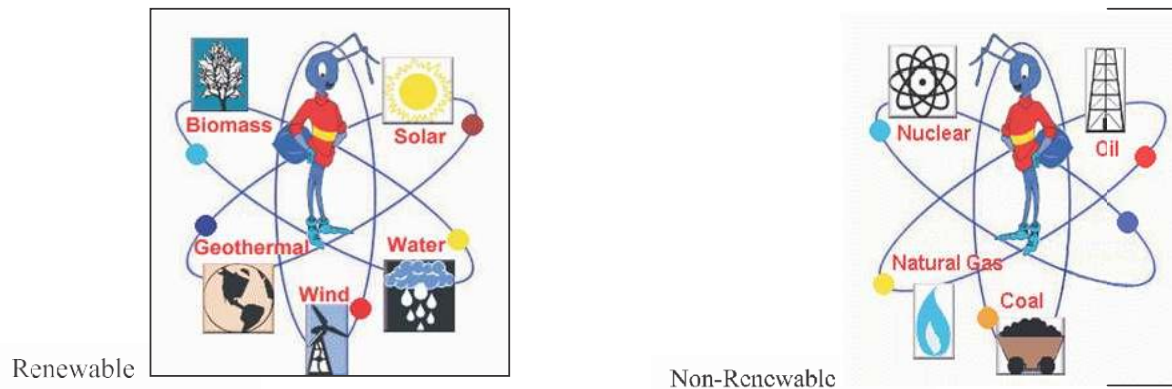

Fig: Renewable and Non-Renewable Energy

## 1.3 Conventional and Non-conventional energy resources:

### Conventional Energy:

Conventional energy resources which are being traditionally used for many decades and were in common use around oil crisis of 1973 are called conventional energy resources, e.g., fossil fuel, nuclear and hydro resources.

### Non-conventional energy:

Non-conventional energy resources which are considered for large – scale use after oil crisis of 1973, are called non-conventional energy sources, e.g., solar, wind, biomass, etc.

## Energy Consumption and Standard Of Living:

The energy consumption of a nation can be broadly divided into the following areas or sectors depending on energy-related activities. These can be further subdivided into subsectors:

- Domestic sector (houses and offices including commercial buildings)
- Transportation sector
- Agriculture sector
- Industry sector

Consumption of a large amount of energy in a country indicates increased activities in these sectors. This may imply better comforts at home due to use of various appliances, better transport facilities and more agricultural and industrial production. All of this amount to a better quality of life. Therefore, the per capita energy consumption of a country is an index of the standard of living or prosperity (i.e. income) of the people of the country.

### 1.4 Global Primary Energy Reserves

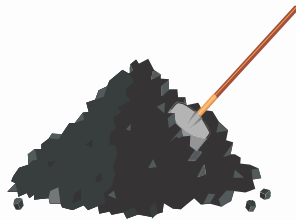

#### Coal

The proven global coal reserve was estimated to be 9,84,453 million tonnes by end of 2003. The USA had the largest share of the global reserve (25.4%) followed by Russia (15.9%), China (11.6%). India was 4<sup>th</sup> in the list with 8.6%.

#### Oil:

The global proven oil reserve was estimated to be 1147 billion barrels by the end of 2003. Saudi Arabia had the largest share of the reserve with almost 23%. (One barrel of oil is approximately 160 liters)



#### Gas

The global proven gas reserve was estimated to be 176 trillion cubic meters by the end of 2003. The Russian Federation had the largest share of the reserve with almost 27%. (\*Source: BP Statistical Review of World Energy, June 2004)

#### Global Primary Energy Consumption:

The global primary energy consumption at the end of 2003 was equivalent to 9741 million tons of oil

Equivalent (MTones). The Figure 1.3 shows in what proportions the sources mentioned above contributed to this global figure.

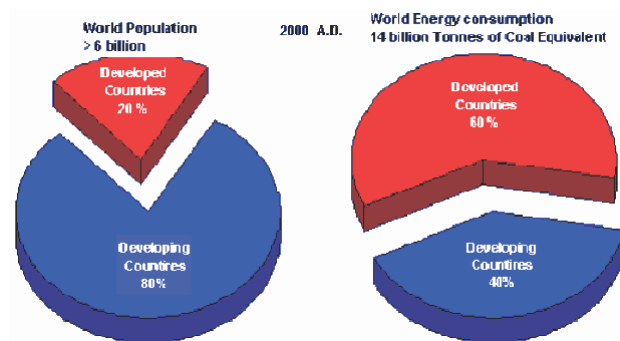

Fig.: Energy Distribution between Developed and Developing Countries

Energy distribution between developed and developing Countries:

Although 80 percent of the world's population lies in the developing countries (a four-fold population increase in the past 25 years), their energy consumption amounts to only 40 percent of the world total energy consumption. The high standards of living in the developed countries are attributable to high energy consumption levels.

Also the rapid population growth in the developing countries has kept the per capita energy consumption low compared with that of highly industrialized developed countries. The world average energy consumption per person is equivalent to 2.2 tons of coal. In industrialized countries, people use four to five times more than the world average and nine times more than the average for the developing countries. An American uses 32 times more commercial energy than an Indian.

## 1.5 Indian Energy Scenario

Coal dominates the energy mix in India, contributing to 55% of the total primary energy production. Over the years, there has been a marked increase in the share of natural gas in primary energy production from 10% in 1994 to 13% in 1999. There has been a decline in the share of oil in primary energy production from 20% to 17% during the same period.

India has huge coal reserves, at least 84,396 million tonnes of proven recoverable reserves (at the end of 2003). These amount to almost 8.6% of the world reserves and it may last for about 230 years at the current Reserve to Production (R/P) ratio. In contrast, the world's proven coal reserves are expected to last only for 192 years at the current R/P ratio.

**Reserves/Production (R/P) ratio-** If the reserves remaining at the end of the year are divided by the production in that year, the result is the length of time that the remaining reserves would last if production were to continue at that level.

India is the fourth largest producer of coal and lignite in the world. Coal production is concentrated in these states (Andhra Pradesh, Uttar Pradesh, Bihar, Madhya Pradesh, Maharashtra, Orissa, Jharkhand, and West Bengal).

## **Oil Supply**

Oil accounts for about 36 % of India's total energy consumption. India today is one of the top ten oil consuming nations in the world and will soon overtake Korea as the third largest consumer of oil in Asia after China and Japan. The country's annual crude oil production is peaked at about 32 million tonne as against the current oil consumption by end of 2007 is expected to reach 136 million tonne(MT), of which domestic production will be only 34 MT. India will have to pay an oil bill of roughly \$50 billion, assuming a weighted average price of \$50 per barrel of crude. In 2003-04, against total export of \$64 billion, oil imports accounted for \$21 billion. India imports 70% of its crude needs mainly from gulf nations. The majority of India's roughly 5.4 billion barrels in oil reserves are located in the Bombay High, upper Assam, Cambay, Krishna-Godavari. In terms of sector wise petroleum product consumption, transport accounts for 42% followed by domestic and industry with 24% and 24% respectively. India spent more than Rs.1,10,000crore on oil imports at the end of 2004.

## **Natural Gas Supply**

Natural gas accounts for about 8.9 per cent of energy consumption in the country. The current demand for natural gas is about 96 million cubic metres per day (mcmd) as against availability of 67 mcmd. By 2007, the demand is expected to be around 200 mcmd. Natural gas reserves are estimated at 660 billion cubic meters.

## **Electrical Energy Supply**

The all India installed capacity of electric power generating stations under utilities was 1,12,581 MW as on 31st May 2004, consisting of 28,860 MW- hydro, 77,931 MW- thermal and 2,720 MW- nuclear and 1,869 MW- wind (Ministry of Power).

## **Nuclear Power Supply**

Nuclear Power contributes to about 2.4 percent of electricity generated in India. India has ten nuclear power reactors at five nuclear power stations producing electricity. More nuclear reactors have also been approved for construction.

## **Hydro Power Supply**

India is endowed with a vast and viable hydro potential for power generation of which only 15% has been harnessed so far. The share of hydropower in the country's total generated units has steadily decreased and it presently stands at 25% as on 31st May 2004. It is assessed that exploitable potential at 60% load factor is 84,000 MW.

## **Final Energy Consumption**

Final energy consumption is the actual energy demand at the user end. This is the difference between primary energy consumption and the losses that takes place in transport, transmission & distribution and refinement. The actual final energy consumption (past and projected) is given

## Sector Wise Energy Consumption in India

The major commercial energy consuming sectors in the country are classified as shown in the Figure 1.5. As seen from the figure, industry remains the biggest consumer of commercial energy and its share in the overall consumption is 49%. (Reference year: 1999/2000)

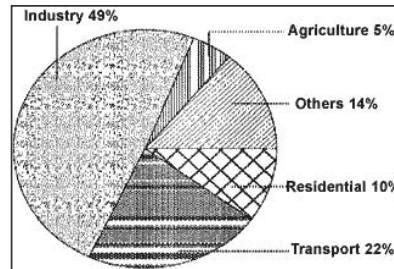

Figure 1.5 Sector Wise Energy Consumption (1999-2000)

## 1.6 Energy Needs of Growing Economy

Economic growth is desirable for developing countries, and energy is essential for economic growth. However, the relationship between economic growth and increased energy demand is not always a straightforward linear one. For example, under present conditions, 6% increase in India's Gross Domestic Product (GDP) would impose an increased demand of 9 % on its energy sector.

In this context, the ratio of energy demand to GDP is a useful indicator. A high ratio reflects energy independence and a strong influence of energy on GDP growth. The developed countries, by focusing on energy efficiency and lower energy-intensive routes, maintain their energy to GDP ratios at values of less than 1. The ratios for developing countries are much higher.

### India's Energy Needs

The plan outlay vis-à-vis share of energy is given in Figure 1.6. As seen from the Figure, 18.0% of the total five-year plan outlay is spent on the energy sector.

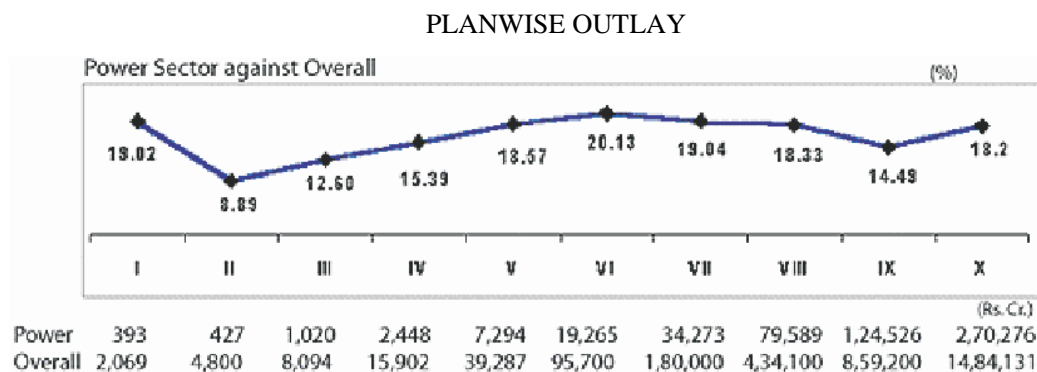

Figure 1.6 Expenditure Towards Energy Sector

## Energy Intensity

Energy intensity is energy consumption per unit of GDP. Energy intensity indicates the development stage of the country. India's energy intensity is 3.7 times of Japan, 1.55 times of USA, 47 times of Asia and 1.5 times of World average.



Figure 1.7 per Capita Energy Consumption

### Coal:

Coal is the predominant energy source for power production in India, generating approximately 70% of total domestic electricity. Energy demand in India is expected to increase over the next 10- 15 years; although new oil and gas plants are planned, coal is expected to remain the dominant fuel for power generation. Despite significant increases in total installed capacity during the last decade, the gap between electricity supply and demand continues to increase. The resulting shortfall has had a negative impact on industrial output and economic growth. However, to meet expected future demand, indigenous coal production will have to be greatly expanded. Production currently stands at around 290 Million tonnes per year, but coal demand is expected to more than double by 2010. Indian coal is typically of poor quality and as such requires to be beneficiated to improve the quality; Coal imports will also need to increase dramatically to satisfy industrial and power generation requirements.

### Oil:

India's demand for petroleum products is likely to rise from 97.7 million tonnes in 2001-02 to around 139.95 million tonnes in 2006-07, according to projections of the Tenth Five-Year Plan. The plan document puts compound annual growth rate (CAGR) at 3.6 % during the plan period. Domestic crude oil production is likely to rise marginally from 32.03 million tonnes in 2001-02 to 33.97 million tonnes by the end of the 10<sup>th</sup> plan period (2006-07). India's self-sufficiency in oil has consistently declined from 60% in the 50s to 30% currently. Same is expected to go down to 8% by 2020. As shown in the figure 1.8, around 92% of India's total oil demand by 2020 has to be met by imports.

## Natural Gas

India's natural gas production is likely to rise from 86.56 million cmpd in 2002-03 to 103.08 million cmpd in 2006-07. It is mainly based on the strength of a more than doubling of production by private operators to 38.25 mm cmpd.

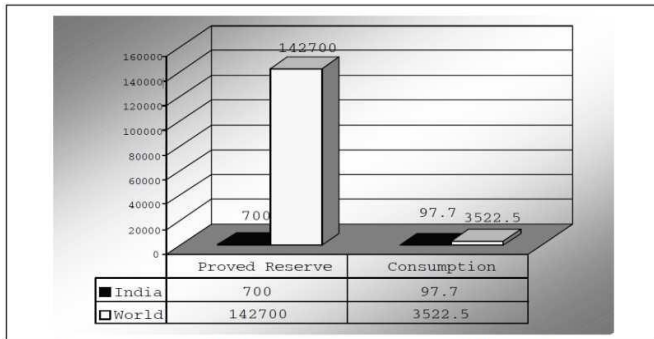
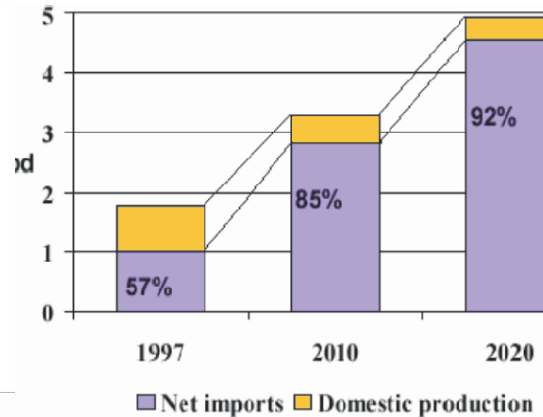

Figure 1.9 Proven Oil Reserve/Consumption (in Million Tonnes)  
India Vs World (At End 2002)



## Electricity

India currently has a peak demand shortage of around 14% and an energy deficit of 8.4%. Keeping this in view and to maintain a GDP (gross domestic product) growth of 8% to 10%, the Government of India has very prudently set a target of 215,804 MW power generation capacity by March 2012 from the level of 100,010 MW as on March 2001, that is a capacity addition of 115,794 MW in the next 11 years. In the area of nuclear power the objective is to achieve 20,000 MW of nuclear generation capacity by the year 2020.

### INDIA'S PERSPECTIVE PLAN FOR POWER FOR ZERO DEFICIT POWER BY 2011/12 (SOURCE TENTH AND ELEVENTH FIVE-YEAR PLAN PROJECTIONS)

	Thermal (Coal) (MW)	Gas / LNG / Diesel (MW)	Nuclear (MW)	Hydro (MW)	Total(MW)
Installed capacity as on March 2001	61,157	Gas: 10,153 Diesel: 864	2720	25,116	100,010
Additional capacity (2001-2012)	53,333	20,408	9380	32,673	115,794
Total capacity as on March 2012	114,490 (53.0%)	31,425 (14.6%)	12,100 (5.6%)	57,789 (26.8%)	215,804

## Coal

Grade wise basic price of coal at the pithead excluding statutory levies for run-of-mine (ROM) coal are fixed by Coal India Ltd from time to time. The pithead price of coal in India compares favorably with price of imported coal. In spite of this, industries still import coal due its higher calorific value and low ash content.



### **Oil:**

As part of the energy sector reforms, the government has attempted to bring prices for many of the petroleum products (naphtha, furnace oil, LSHS, LDO and bitumen) in line with international prices. The most important achievement has been the linking of diesel prices to international prices and a reduction in subsidy. However, LPG and kerosene, consumed mainly by domestic sectors, continue to be heavily subsidized. Subsidies and cross-subsidies have resulted in serious distortions in prices, as they do not reflect economic costs in many cases

### **Natural Gas:**

The government has been the sole authority for fixing the price of natural gas in the country. It has also been taking decisions on the allocation of gas to various competing consumers. The gas prices varies from Rs 5/- to Rs.15/- per cubic meter.

### **Electricity:**

Electricity tariffs in India are structured in a relatively simple manner. While high tension consumers are charged based on both demand (kVA) and energy (kWh), the low-tension (LT) consumer pays only for the energy consumed (kWh) as per tariff system in most of the electricity boards. The price per kWh varies significantly across States as well as customer segments with- in a State. Tariffs in India have been modified to consider the time of usage and voltage level of supply. In addition to the base tariffs, some State Electricity Boards have additional recovery from customers in form of fuel surcharges, electricity duties and taxes. For example, for an industrial consumer the demand charges may vary from Rs. 150 to Rs. 300 per kVA, whereas the energy charges may vary anywhere between Rs. 2 to Rs. 5 per kWh. As for the tariff adjustment mechanism, even when some States have regulatory commissions for tariff review, the decisions to effect changes are still political and there is no automatic adjustment mechanism, which can ensure recovery of costs for the electricityboards.

## **1.7 Energy andEnvironment**

The usage of energy resources in industry leads to environmental damages by polluting the atmosphere.

Few of examples of air pollution are sulphur dioxide ( $\text{SO}_2$ ), nitrous oxide ( $\text{NO}_x$ ) and carbon monoxide ( $\text{CO}$ ) emissions from boilers and furnaces, Chlorofluo carbons (CFC) emissions from refrigerants use, etc. In chemical and fertilizers industries, toxic gases are released. Cement plants and power plants spew out particulate matter.

Typical inputs, outputs, and emissions for a typical industrial process are shown in Figure.

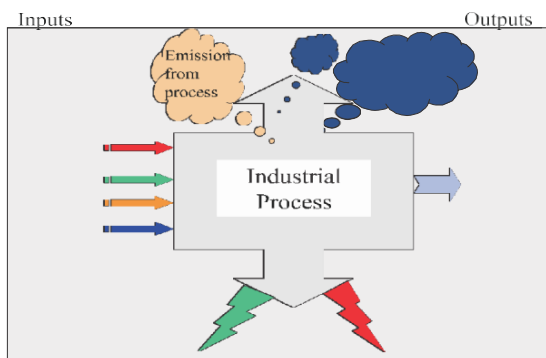

## **Air Pollution**

A variety of air pollutants have known or suspected harmful effects on human health and the environment. These air pollutants are basically the products of combustion from fossil fuel use. Air pollutants from these sources may not only create problems near to these sources but also can cause problems far away. Air pollutants can travel long distances, chemically react in the atmosphere to produce secondary pollutants such as acid rain or ozone.

### **Evolutionary Trends in Pollution Problems**

Both developed and rapidly industrializing countries, the major historic air pollution problem has typically been high levels of smoke and SO<sub>2</sub> arising from the combustion of sulphur-containing fossil fuels such as coal for domestic and industrial purposes.

Smog's resulting from the combined effects of black smoke, sulphate / acid aerosol and fog have been seen in European cities until few decades ago and still occur in many cities in developing world. In developed countries, this problem has significantly reduced over recent decades as a result of changing fuel-use patterns; the increasing use of cleaner fuels such as natural gas, and the implementation of effective smoke and emission control policies.

In both developed and developing countries, the major threat to clean air is now posed by traffic emissions. Petrol- and diesel engine motor vehicles emit a wide variety of pollutants, principally carbon monoxide (CO), oxides of nitrogen (NO<sub>x</sub>), volatile organic compounds (VOCs) and particulates, which have an increasing impact on urban air quality.

In addition, photochemical reactions resulting from the action of sunlight on NO<sub>2</sub> and VOCs from vehicles leads to the formation of ozone, a secondary long-range pollutant, which impacts in rural areas often far from the original emission site. Acid rain is another long-range pollutant influenced by vehicle NO<sub>2</sub> emissions.

Industrial and domestic pollutant sources, together with their impact on air quality, tend to be steady-state or improving over time. However, traffic pollution problems are worsening world-wide. The problem may be particularly severe in developing countries with dramatically increasing vehicle population, infrastructural limitations, poor engine/emission control technologies and limited provision for maintenance or vehicle regulation.

The principle pollutants produced by industrial, domestic and traffic sources are sulphur dioxide, nitrogen oxides, particulate matter, carbon monoxide, ozone, hydrocarbons, benzene, 1,3-butadiene, toxic organic micro pollutants, lead and heavy metals. Brief introduction to the principal pollutants are as follows:

**Sulphur dioxide** is a corrosive acid gas, which combines with water vapour in the atmosphere to produce acid rain. Both wet and dry depositions have been implicated in the damage and destruction of vegetation and in the degradation of soils, building materials and water courses. SO<sub>2</sub> in ambient air is also associated with asthma and chronic bronchitis. The principal source of this gas is power stations and industries burning fossil fuels, which contain sulphur.

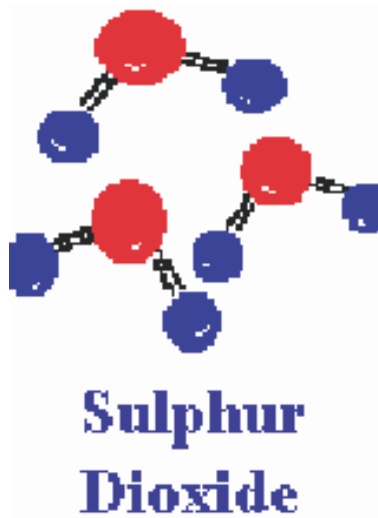
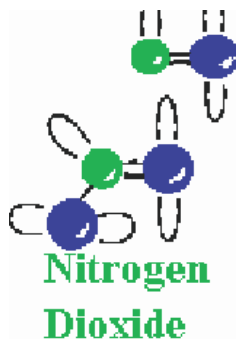

Fig: Acid Rain

**Nitrogen oxides** are formed during high temperature combustion processes from the oxidation of nitrogen in the air or fuel. The principal source of nitrogen oxides - nitric oxide (NO) and nitrogen dioxide (NO<sub>2</sub>), collectively known as NO<sub>x</sub> is road traffic. NO and NO<sub>2</sub> concentrations are greatest in urban areas where traffic is heaviest. Other important sources are power stations and industrial processes.



Nitrogen oxides are released into the atmosphere mainly in the form of NO, which is then readily oxidized to NO<sub>2</sub> by reaction with ozone. Elevated levels of NO<sub>2</sub> occur in urban environments under stable meteorological conditions, when the air mass is unable to disperse.

Nitrogen dioxide has a variety of environmental and health impacts. It irritates the respiratory system and may worsen asthma and increase susceptibility to infections. In the presence of sunlight, it reacts with hydrocarbons to produce photochemical pollutants such as Ozone.

Nitrogen oxides combine with water vapour to form nitric acid. This nitric acid is in turn removed from the atmosphere by direct deposition to the ground, or transfer to aqueous droplets (e.g. cloud or rainwater), thereby contributing to acid deposition.

## Acidification from SO<sub>2</sub> and NO<sub>2</sub>

Acidification of water bodies and soils, and the consequent impact on agriculture, forestry and fisheries are the result of the re-deposition of acidifying compounds resulting principally from the oxidation of primary SO<sub>2</sub> and NO<sub>2</sub> emissions from fossil fuel combustion. Deposition may be by either wet or dry processes, and acid deposition studies often need to examine both of these acidification routes.

Airborne **particulate matter** varies widely in its physical and chemical composition, source and particle size. PM<sub>10</sub> particles (the fraction of particulates in air of very small size (<10 μm)) are of major current concern, as they are small enough to penetrate deep into the lungs and so potentially pose significant health risks. In addition, they may carry surface-absorbed carcinogenic compounds into the lungs. Larger particles, combustion, where transport of hot exhaust vapour into a cooler exhaust pipe can lead to spontaneous nucleation of "carbon" particles before emission. Secondary particles are typically formed when low volatility products are generated in the atmosphere, for example the oxidation of sulphur dioxide to sulphuric acid. The atmospheric lifetime of particulate matter is strongly related to particle size, but may be as long as 10 days for particles of about 1mm indiameter.

Concern about the potential health impacts of PM<sub>10</sub> has increased very rapidly over recent years. Increasingly, attention has been turning towards monitoring of the smaller particle fraction PM<sub>2.5</sub> capable of penetrating deepest into the lungs, or to even smaller size fractions or total particle numbers.

**Carbon monoxide** (CO) is a toxic gas, which is emitted into the atmosphere as a result of combustion processes, and from oxidation of hydrocarbons and other organic compounds. In urban areas, CO is produced almost entirely (90%) from road traffic emissions. CO at levels found in ambient air may reduce the oxygen-carrying capacity of the blood. It survives in the atmosphere for a period of approximately 1 month and finally gets oxidized to carbon dioxide(CO<sub>2</sub>).

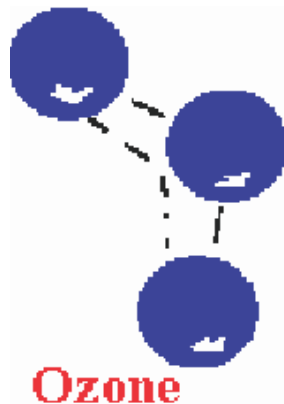

**Ground-level ozone** (O<sub>3</sub>), unlike other primary pollutants mentioned above, is not emitted directly into the atmosphere, but is a secondary pollutant produced by reaction between nitrogen dioxide (NO<sub>2</sub>), hydrocarbons and sunlight. Ozone can irritate the eyes and air passages causing breathing difficulties and may increase susceptibility to infection. It is a highly reactive chemical, capable of attacking surfaces, fabrics and rubber materials. Ozone is also toxic to some crops, vegetation and trees.

Whereas nitrogen dioxide (NO<sub>2</sub>) participates in the formation of ozone, nitrogen oxide (NO) destroys ozone to form oxygen (O<sub>2</sub>) and nitrogen dioxide (NO<sub>2</sub>). For this reason, ozone levels are not as high in urban areas (where high levels of NO are emitted from vehicles) as in rural areas. As the nitrogen oxides and hydrocarbons are transported out of urban areas, the ozone-destroying NO is oxidized to NO<sub>2</sub>, which participates in ozone formation.

### Hydrocarbons:

There are two main groups of hydrocarbons of concern: volatile organic compounds (VOCs) and polycyclic aromatic hydrocarbons (PAHs). VOCs are released in vehicle exhaust gases either as unburned fuels or as combustion products, and are also emitted by the evaporation of solvents and motor fuels. Benzene and 1,3-butadiene are of particular concern, as they are known carcinogens. Other VOCs are important because of the role they play in the photochemical formation of ozone in the atmosphere.

**Benzene** is an aromatic VOC, which is a minor constituent of petrol (about 2% by volume). The main sources of benzene in the atmosphere are the distribution and combustion of petrol. Of these, combustion by petrol vehicles is the single biggest source (70% of total emissions), whilst the refining, distribution and evaporation of petrol from vehicles accounts for approximately a further 10% of total emissions. Benzene is emitted in vehicle exhaust not only as unburnt fuel but also as a product of the decomposition of other aromatic compounds. Benzene is a known human carcinogen.

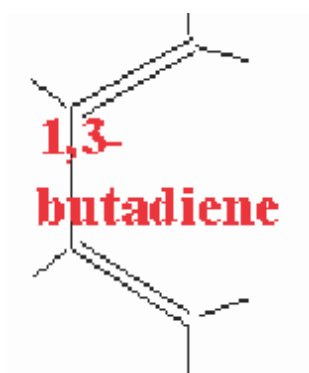

**1,3-butadiene**, like benzene, is a VOC emitted into the atmosphere principally from fuel combustion of petrol and diesel vehicles. Unlike benzene, however, it is not a constituent of the fuel but is produced by the combustion of olefins. 1,3-butadiene is also an important chemical in certain industrial processes, particularly the manufacture of synthetic rubber. It is handled in bulk at a small number of industrial locations. Other than in the vicinity of such locations, the dominant source of 1,3-butadiene in the atmosphere are the motor vehicles. 1,3-Butadiene is also a known, potent, human carcinogen.

**TOMPs (Toxic Organic Micro pollutants)** are produced by the incomplete combustion of fuels. They comprise a complex range of chemicals some of which, although they are emitted in very small quantities, are highly toxic or and carcinogenic. Compounds in this category include:

- PAHs (PolyAromaticHydrocarbons)
- PCBs (PolyChlorinatedBiphenyls)

- Dioxins
- Furans

### Heavy Metals and Lead

Particulate metals in air result from activities such as fossil fuel combustion (including vehicles), metal processing industries and waste incineration. There are currently no emission standards for metals other than lead. Lead is a cumulative poison to the central nervous system, particularly detrimental to the mental development of children.

Lead is the most widely used non-ferrous metal and has a large number of industrial applications. Its single largest industrial use worldwide is in the manufacture of batteries and it is also used in paints, glazes, alloys, radiation shielding, tank lining and piping.

As tetraethyl lead, it has been used for many years as an additive in petrol; with the increasing use of unleaded petrol, however, emissions and concentrations in air have reduced steadily in recent years.

### Climatic Change:

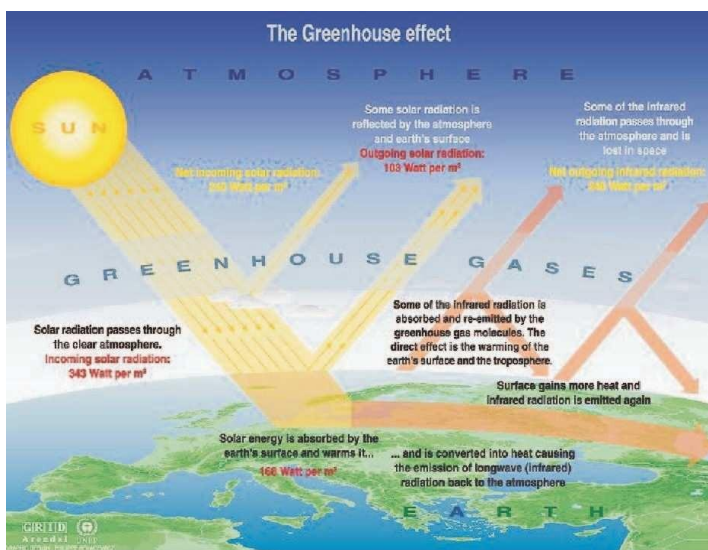

Fig: The greenhouse effect

Human activities, particularly the combustion of fossil fuels, have made the blanket of green- house gases (water vapour, carbon dioxide, methane, ozone etc.) around the earth thicker. The resulting increase in global temperature is altering the complex web of systems that allow life to thrive on earth such as rainfall, wind patterns, ocean currents and distribution of plant and animalsspecies.GreenhouseEffect and the Carbon.

### Cycle:

Life on earth is made possible by energy from the sun, which arrives mainly in the form of visible light. About 30 percent of the sunlight is scattered back into space by outer atmosphere and the balance 70 percent reaches the earth's surface, which reflects it in form of infrared radiation. The escape of slow

moving infrared radiation is delayed by the green house gases. A thicker blanket of greenhouse gases traps more infrared radiation and increase the earth's temperature (Refer Figure 1.11).

Greenhouse gases makeup only 1 percent of the atmosphere, but they act as a blanket around the earth, or like a glass roof of a greenhouse and keep the earth 30 degrees warmer than it would be otherwise - without greenhouse gases, earth would be too cold to live. Human activities that are responsible for making the greenhouse layer thicker are emissions of carbon dioxide from the combustion of coal, oil and natural gas; by additional methane and nitrous oxide from farming activities and changes in land use; and by several man made gases that have a long life in the atmosphere.

The increase in greenhouse gases is happening at an alarming rate. If greenhouse gases emissions continue to grow at current rates, it is almost certain that the atmospheric levels of carbon dioxide will increase twice or thrice from pre-industrial levels during the 21st century.

Even a small increase in earth's temperature will be accompanied by changes in climate- such as cloud cover, precipitation, wind patterns and duration of seasons. In an already highly crowded and stressed earth, millions of people depend on weather patterns, such as monsoon rains, to continue as they have in the past. Even minimum changes will be disruptive and difficult.

Carbon dioxide is responsible for 60 percent of the "enhanced greenhouse effect". Humans are burning coal, oil and natural gas at a rate that is much faster than the rate at which these fossil fuels were created. This is releasing the carbon stored in the fuels into the atmosphere and upsetting the carbon cycle (a precise balanced system by which carbon is exchanged between the air, the oceans and land vegetation taking place over millions of years). Currently, carbon dioxide levels in the atmosphere are rising by over 10 percent every 20 years.

Current evidence of climatic change, cyclones, storm, hurricanes are occurring more frequently and floods and draughts are more intense than before. This increase in extreme weather events cannot be explained away as random events.

This trend toward more powerful storms and hotter, longer dry periods is predicted by computer models. Warmer temperatures mean greater evaporation, and a warmer atmosphere is able to hold more moisture and hence there is more water aloft that can fall as precipitation. Similarly, dry regions are prone to lose still more moisture if the weather is hotter and hence this leads to more severe droughts and desertification.

### **Future Effects**

Even the minimum predicted shifts in climate for the 21st century are likely to be significant and disruptive. Predictions of future climatic changes are wide-ranging. The global temperature may climb from 1.4 to 5.8 degrees C; these sea level may rise from 9 to 88 cm. Thus, increases in sea level this century are expected to range from significant to catastrophic. This uncertainty reflects the complexity, interrelatedness, and sensitivity of the natural systems that make up the climate.

## **Severe Storms and Flooding**

The minimum warming forecast for the next 100 years is more than twice the 0.6 degree C increase that has occurred since 1900 and that earlier increase is already having marked consequences. Extreme weather events, as predicted by computer models, are striking more often and can be expected to intensify and become still more frequent. A future of more severe storms and floods along the world's increasingly crowded coastlines is likely.

## **Food Shortages**

Although regional and local effects may differ widely, a general reduction is expected in potential crop yields in most tropical and sub-tropical regions. Mid-continental areas such as the United States' "grain belt" and vast areas of Asia are likely to become dry. Sub-Saharan Africa where dry land agriculture relies solely on rain, the yields would decrease dramatically even with minimum increase in temperature. Such changes could cause disruptions in food supply in a world is already afflicted with food shortages and famines.

## **Dwindling Freshwater supply**

Salt-water intrusion from rising sea levels will reduce the quality and quantity of freshwater supplies. This is a major concern, since billions of people on earth already lack access to fresh- water. Higher ocean levels already are contaminating underground water sources in many parts of the world.

## **Loss of Biodiversity**

Most of the world's endangered species (some 25 percent of mammals and 12 percent of birds) may become extinct over the next few decades as warmer conditions alter the forests, wetlands, and rangelands they depend on, and human development blocks them from migrating elsewhere.

## **Increased Diseases**

Higher temperatures are expected to expand the range of some dangerous "vector-borne" diseases, such as malaria, which already kills 1 million people annually, most of them children.

A World under Stress Ongoing environmentally damaging activities such as overgrazing, deforestation, and denuded agricultural soils means that nature will be more vulnerable than previously to changes in climate.

Similarly, the world's vast human population, much of it poor, is vulnerable to climate stress. Millions live in dangerous places such as floodplains or in slums around the big cities of the developing world. Often there is nowhere else for population to move. In the distant past, man and his ancestors migrated in response to changes in habitat. There will be much less room for migration in future.

Global warming almost certainly will be unfair. The industrialized countries of North America and Western Europe, and other countries such as Japan, are responsible for the vast amount of past and current greenhouse-gas emissions. These emissions are incurred for the high standards of living enjoyed by the people in those countries.

Yet those to suffer most from climate change will be in the developing world. They have fewer resources for coping with storms, with floods, with droughts, with disease outbreaks, and with disruptions to food and water supplies. They are eager for economic development themselves, but may find that this already difficult process has become more difficult because of climate change. The poorer nations of the world have done almost nothing



to cause global warming yet is most exposed to its effects.

### **Acid Rain**

Acid rain is caused by release of  $\text{SO}_x$  and  $\text{NO}_x$  from combustion of fossil fuels, which then mix with water vapor in atmosphere to form sulphuric and nitric acids respectively.

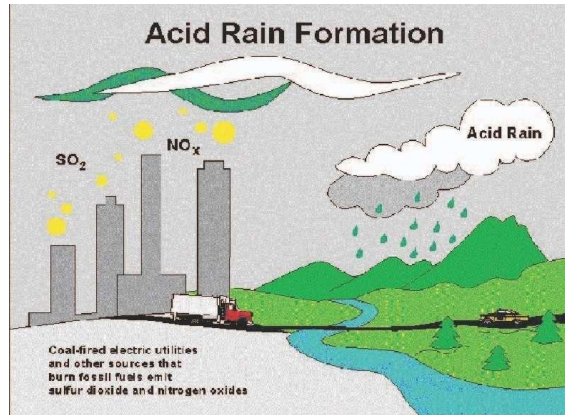

The effects of acid rain are as follows:

- Acidification of lakes, streams, and soils
- Direct and indirect effects (release of metals, for example: Aluminum which washes away plant nutrients)
- Killing of wildlife (trees, crops, aquatic plants, and animals)
- Decay of building materials and paints, statues, and sculptures
- Health problems (respiratory, burning- skin and eyes)

### **1.8 Energy Security:**

The basic aim of energy security for a nation is to reduce its dependency on the imported energy sources for its economic growth.

India will continue to experience an energy supply shortfall throughout the forecast period. This gap has widened since 1985, when the country became a net importer of coal. India has been unable to raise its oil production substantially in the 1990s. Rising oil demand of close to

10 percent per year has led to sizable oil import bills. In addition, the government subsidizes refined oil product prices, thus compounding the overall monetary loss to the government.

Imports of oil and coal have been increasing at rates of 7% and 16% per annum respectively during the period 1991-99. The dependence on energy imports is projected to increase in the future. Estimates indicate that oil imports will meet 75% of total oil consumption requirements and coal imports will meet 22% of total coal consumption

As per requirements in 2006. The imports of gas and LNG (liquefied natural gas) are likely to increase in the coming years. This energy import dependence implies vulnerability to external price shocks and supply fluctuations, which threaten the energy security of the country.

Increasing dependence on oil imports means reliance on imports from the Middle East, a region susceptible to

disturbances and consequent disruptions of oil supplies. This calls for diversification of sources of oil imports. The need to deal with oil price fluctuations also necessitates measures to be taken to reduce the oil dependence of the economy, possibly through fiscal measures to reduce demand, and by developing alternatives to oil, such as natural gas and renewable energy.

Some of the strategies that can be used to meet future challenges to their energy security are

- Building stockpiles
- Diversification of energy supply sources
- Increased capacity of fuel switching
- Demand restraint,
- Development of renewable energy sources.
- Energy efficiency
- Sustainable development

Although all these options are feasible, their implementation will take time. Also, for countries like India, reliance on stockpiles would tend to be slow because of resource constraints. Besides, the market is not sophisticated enough or the monitoring agencies experienced enough to predict the supply situation in time to take necessary action. Insufficient storage capacity is another cause for worry and needs to be augmented, if India has to increase its energy stock pile.

However, out of all these options, the simplest and the most easily attainable is reducing demand through persistent energy conservation efforts.

### **Energy Conservation and its Importance**

Coal and other fossil fuels, which have taken three million years to form, are likely to deplete soon. In the last two hundred years, we have consumed 60% of all resources. For sustainable development, we need to adopt energy efficiency measures.

Today, 85% of primary energy comes from non-renewable, and fossil sources (coal, oil, etc.). These reserves are continually diminishing with increasing consumption and will not exist for future generations

What is Energy Conservation?

Energy Conservation and Energy Efficiency are separate, but related concepts. Energy conservation is achieved when growth of energy consumption is reduced, measured in physical terms. Energy Conservation can, therefore, be the result of several processes or developments, such as productivity increase or technological progress. On the other hand Energy efficiency is achieved when energy intensity in a specific product, process or area of production or consumption is reduced without affecting output, consumption or comfort levels. Promotion of energy efficiency will contribute to energy conservation and is therefore an integral part of energy conservation promotional policies.

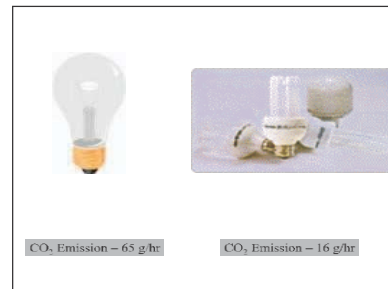
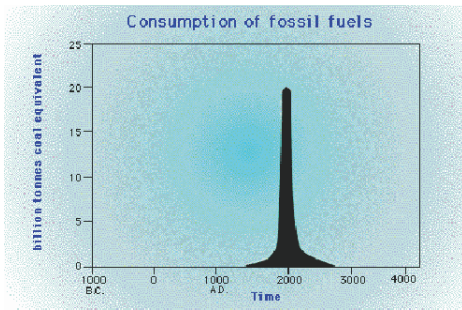

Energy efficiency is often viewed as a resource option like coal, oil or natural gas. It provides additional economic value by preserving the resource base and reducing pollution. For example, replacing traditional light bulbs with Compact Fluorescent Lamps (CFLs) means you will use only 1/4th of the energy to light a room. Pollution levels also reduce by the same amount.

Nature sets some basic limits on how efficiently energy can be used, but in most cases our products and manufacturing processes are still a long way from operating at this theoretical limit. Very simply, energy efficiency means using less energy to perform the same function. Although, energy efficiency has been in practice ever since the first oil crisis in 1973, it has today assumed even more importance because of being the most cost-effective and reliable means of mitigating the global climatic change.

Recognition of that potential has led to high expectations for the control of future CO<sub>2</sub> emissions through even more energy efficiency improvements than have occurred in the past. The industrial sector accounts for some 41 per cent of global primary energy demand and approximately the same share of CO<sub>2</sub> emissions.

## 1.9 Energy Strategy for the Future

The energy strategy for the future could be classified into immediate, medium-term and long-term strategy. The various components of these strategies are listed below:

Immediate-term strategy:

- Rationalizing the tariff structure of various energy products.
- Optimum utilization of existing assets
- Efficiency in production systems and reduction in distribution losses, including those in traditional energy sources.
- Promoting R&D, transfer and use of technologies and practices for environmentally sound energy systems, including new and renewable energy sources.

### Medium-term strategy:

Demand management through greater conservation of energy, optimum fuel mix, structural changes in the economy, an appropriate modal mix in the transport sector, i.e. greater dependence on rail than on road for the movement of goods and passengers and a shift away from private modes to public modes for passenger transport; changes in design of different products to reduce the material intensity of those products, recycling, etc.

There is need to shift to less energy-intensive modes of transport. This would include measures to improve the transport infrastructure viz. roads, better design of vehicles, use of compressed natural gas (CNG) and synthetic fuel, etc. Similarly, better urban planning would also reduce the demand for energy use in the transport sector.

There is need to move away from non-renewable to renewable energy sources viz. solar, wind, biomass energy, etc.

### Long-term strategy:

- Reduction of natural gas flaring Improving energy infrastructure
- Building new refineries
- Creation of urban gas transmission and distribution network
- Maximizing efficiency of rail transport of coal production.
- Building new coal and gas fired power stations.

Enhancing energy efficiency. Improving energy efficiency in accordance with national, socio-economic, and environmental priorities

Promoting of energy efficiency and emission standards

Labeling programs for products and adoption of energy efficient technologies in large industries

Deregulation and privatization of energy sector

- Reducing cross subsidies on oil products and electricity tariffs
- Decontrolling coal prices and making natural gas prices competitive
- Privatization of oil, coal and power sectors for improved efficiency. Investment legislation to attract foreign investments.
- Streamlining approval process for attracting private sector participation in power generation, transmission and distribution.

## Solar Energy:

Introduction:

Solar energy is an important, clean, cheap and abundantly available renewable energy. It is received on Earth in cyclic, intermittent and dilute form with very low power density 0 to 1 kW/m<sup>2</sup>. Solar energy received on the ground level is affected by atmospheric clarity, degree of latitude, etc. For design purpose, the variation of available solar power, the optimum tilt angle of solar flat plate collectors, the location and orientation of the heliostats should be calculated.

Units of solar power and solar energy:

In SI units, energy is expressed in Joule. Other units are anglely and Calorie where

$$1 \text{ angle} = 1 \text{ Cal/cm}^2 \cdot \text{day}$$

$$1 \text{ Cal} = 4,186 \text{ J}$$

For solar energy calculations, the energy is measured as an hourly or monthly or yearly average and is expressed in terms of kJ/m<sup>2</sup>/day or kJ/m<sup>2</sup>/hour. Solar power is expressed in terms of W/m<sup>2</sup> or kW/m<sup>2</sup>.

### Essential subsystems in a solar energy plant:

1. **Solar collector or concentrator:** It receives solar rays and collects the energy. It may be of following types:
  - a) Flat plate type without focusing
  - b) Parabolic trough type with line focusing
  - c) Paraboloid dish with central focusing
  - d) Fresnel lens with Centre focusing
  - e) Heliostats with center receiver focusing

**Energy transport medium:** Substances such as water/ steam, liquid metal or gas are used to transport the thermal energy from the collector to the heat exchanger or thermal storage. In solar PV systems energy transport occurs in electrical form.

2. **Energy storage:** Solar energy is not available continuously. So we need an energy storage medium for maintaining power supply during nights or cloudy periods. There are three major types of energy storage: a) Thermal energy storage; b) Battery storage; c) Pumped storage hydro-electric plant.

3. **Energy conversion plant:** Thermal energy collected by solar collectors is used for producing steam, hot water, etc. Solar energy converted to thermal energy is fed to steam- thermal or gas-thermal power plant.

4. **Power conditioning, control and protection system:** Load requirements of electrical energy vary with time. The energy supply has certain specifications like voltage, current, frequency, power etc.

The power conditioning unit performs several functions such as control, regulation, conditioning, protection, automation, etc.

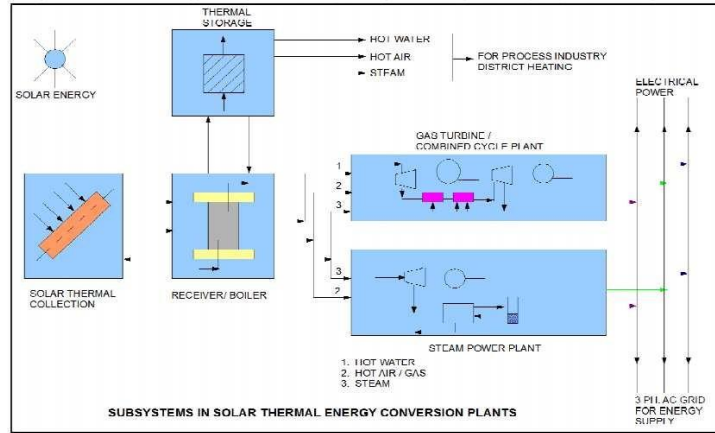

5. **Alternative or standby power supply:** The backup may be obtained as power from electrical network or standby diesel generator.

6. **Energy from the sun:** The sun radiates about  $3.8 \times 10^{26}$  W of power in all the directions. Out of this about  $1.7 \times 10^{17}$  W is received by earth. The average solar radiation outside the earth's atmosphere is  $1.35 \text{ kW/m}^2$  varying from  $1.43 \text{ kW/m}^2$  (in January) to  $1.33 \text{ kW/m}^2$  (in July).

Solar thermal energy (STE) is a form of energy and a technology for harnessing solar energy to generate thermal energy or electrical energy for use in industry, and in the residential and commercial sectors. The first installation of solar thermal energy equipment occurred in the Sahara Desert approximately in 1910

when a steam engine was run on steam produced by sunlight. Because liquid fuel engines were developed and found more convenient, the Sahara project was abandoned, only to be revisited several decades later.

Solar thermal collectors are classified by the United States Energy Information Administration as low-, medium-, or high-temperature collectors. Low-temperature collectors are flat plates generally used to heat swimming pools. Medium-temperature collectors are also usually flat plates but are used for heating water or air for residential and commercial use. High-temperature collectors concentrate sunlight using mirrors or lenses and are generally used for fulfilling heat requirements up to  $300 \text{ deg C} / 20 \text{ bar}$  pressure in industries, and for electric power production. However, there is a term that is used for both the applications. Concentrated Solar Thermal (CST) for fulfilling heat requirements in industries and Concentrated Solar Power (CSP) when the heat collected is used for power generation. CST and CSP are not replaceable in terms of application.

The 377 MW Ivanpah Solar Power Facility is the largest solar power plant in the world, located in the Mojave Desert of California. Other large solar thermal plants include the SEGS installation (354 MW), also in the Mojave, as well as the Solnova Solar Power Station (150 MW), the Andasol solar power station (150 MW), and Extresol Solar Power plant (100 MW), all in Spain.



The first three units of [Solnova](#) in the foreground, with the two towers of the [PS10](#) and [PS20](#) solar power stations in the background.

A solar thermal collector system gathers the heat from the solar radiation and gives it to the heat transport fluid. The heat-transport fluid receives the heat from the collector and delivers it to the thermal storage tank, boiler steam generator, heat exchanger etc. Thermal storage system stores heat for a few hours. The heat is released during cloudy hours and at night. Thermal-electric conversion system receives thermal energy and drives steam turbine generator or gas turbine generator. The electrical energy is supplied to the electrical load or to the AC grid. Applications of solar thermal energy systems range from simple solar cooker of 1 kW rating to complex solar central receiver thermal power plant of 200 MW rating.

## Unit –II

### **SOLAR ENERGY COLLECTION**

#### SOLAR COLLECTORS

Solar thermal energy is the most readily available source of energy. The Solar energy is most important kind of non-conventional source of energy which has been used since ancient times, but in a most primitive manner. The abundant solar energy available is suitable for harnessing for a number of applications. The application of solar thermal energy system ranges from solar cooker of 1 kw to power plant of 200MW. These systems are grouped into low temperature (<150°C), medium temperature (150-300°C) applications.

#### Solar Collectors

Solar collectors are used to collect the solar energy and convert the incident radiations into thermal energy by absorbing them. This heat is extracted by flowing fluid (air or water or mixture with antifreeze) in the tube of the collector for further utilization in different applications.

The collectors are classified as;

Non concentrating collectors

Concentrating (focusing) collectors

Non Concentrating Collectors

In these collectors the area of collector to intercept the solar radiation is equal to the absorber plate and has concentration ratio of 1. Flat Plate Collectors (Glaze Type) Flat plate collector is most important part of any solar thermal energy system. It is simplest in design and both direct and diffuse radiations are absorbed by collector and converted into useful heat. These collectors are suitable for heating to temperature below 100°C.

#### Disadvantages

Large heat losses by conduction and radiation because of large area.

No tracking of sun.

Low water temperature is achieved.

The constructional details of flat plate collector is given below

1. Insulated Box: The rectangular box is made of thin G.I sheet and is insulated from sides and bottom using glass or mineral wool of thickness 5 to 8 cm to reduce losses from conduction to back and side wall. The box is tilted at due south and a tilt angle depends on the latitude of location. The face area of the collector box is kept between 1 to 2m<sup>2</sup>.



Transparent Cover: This allows solar energy to pass through and reduces the convective heat losses from the absorber plate through air space. The transparent tempered glass cover is placed on top of rectangular box to trap the solar energy and sealed by rubber gaskets to prevent the leakage of hot air. It is made of plastic/glass but glass is most favorable because of its transmittance and low surface degradation. However with development of improved quality of plastics, the degradation quality has been improved. The plastics are available at low cost, light in weight and can be used to make tubes, plates and cover but are suitable for low temperature application 70-120°C with single cover plate or up to 150°C using double cover plate. The thickness of glass cover 3 to 4 mm is commonly used and 1 to 2 covers with spacing 1.5 to 3 cm are generally used between plates. The temperature of glass cover is lower than the absorber plate and is a good absorber of thermal energy and reduces convective and radiative losses of sky.

a) Absorber Plate: It intercepts and absorbs the solar energy. The absorber plate is made of copper, aluminum or steel and is in the thickness of 1 to 2 mm. It is the most important part of collector along with the tubes products passing the liquid or air to be heated. The plate absorbs the maximum solar radiation incident on it through glazing (cover plate) and transfers the heat to the tubes in contact with minimum heat losses to atmosphere. The plate is black painted and provided with selective material coating to increase its absorption and reduce the emission. The absorber plate has high absorption (80-95%) and low transmission/reflection.

b) Tubes: The plate is attached to a series of parallel tubes or one serpentine tube through which water or other liquid passes. The tubes are made of copper, aluminum or steel in the diameter 1 to 1.5 cm and are brazed, soldered on top/bottom of the absorber water equally in all the tubes and collect it back from the other end. The header pipe is made of same material as tube and of larger diameter. Now-a-days the tubes are made of plastic but they have low thermal conductivity and higher coefficient of expansion than metals. Copper and aluminum are likely to get corroded with saline liquids and steel tubes with inhibitors are used at such places.

Removal of Heat: These systems are best suited to applications that require low temperatures. Once the heat is absorbed on the absorber plate it must be removed fast and delivered to the place of storage for further use. As the liquid circulates through the tubes, it absorbs the heat from absorber plate of the collectors. The heated liquid moves slowly and the losses from collector will increase because of rise of high temperature of collector and will lower the efficiency. Flat-plate solar collectors are less efficient in cold weather than in warm weather. Factors affecting the Performance of Flat Plate Collector.

The different factors affecting the performance of system are:

- Incident Solar Radiation: The efficiency of collector is directly related with solar radiation falling on it and increases with rise in temperature.
- Number of Cover Plate: The increase in number of cover plate reduces the internal convective heat losses but also prevents the transmission of radiation inside the collector. More than two cover plate should not be used to optimize the system.

- **Spacing:** The more space between the absorber and cover plate the less internal heat losses. The collector efficiency will be increased. However on the other hand, increase in space between them provides the shading by side wall in the morning and evening and reduces the absorbed solar flux by 2-3% of system. The spacing between absorber and cover plate is kept 2-3 cm to balance the problem.

**Collector Tilt:** The flat plate collectors do not track the sun and should be tilted at angle of latitude of the location for an average better performance. However with changing declination angle with seasons the optimum tilt angle is kept  $\Phi \pm 15^\circ$ .

The collector is placed with south facing at northern hemisphere to receive maximum radiation throughout the day.

**Selective Surface:** Some materials like nickel black ( $\alpha = 0.89$ ,  $\epsilon = 0.15$ ) and black chrome ( $\alpha = 0.87$ ,  $\epsilon = 0.088$ ), copper oxide ( $\alpha = 0.89$ ,  $\epsilon = 0.17$ ) etc. are applied chemically on the surface of absorber in a thin layer of thickness  $0.1 \mu\text{m}$ . These chemicals have high degree of absorption ( $\alpha$ ) to short wave radiation ( $< 4 \mu\text{m}$ ) and low emission ( $\epsilon$ ) of long wave radiations ( $> 4 \mu\text{m}$ ). The higher absorption of solar energy increase the temperature of absorber plate and working fluid. The top losses reduce and the efficiency of the collector increases. The selective surface should be able to withstand high temperature of  $300\text{-}400^\circ\text{C}$ , cost less, should not oxidize and be corrosive resistant. The property of material should not change with time.

**Inlet Temperature:** With increase in inlet temperature of working fluid the losses increase to ambient. The high temperature fluid absorbed the less heat from absorber plate because of low temperature difference and increases the top loss coefficient. Therefore the efficiency of collector get reduced with rise in inlet temperature.

**Dust on cover Plate:** The efficiency of collector decreases with dust particles on the cover plate because the transmission radiation decreases by 1%. Frequent cleaning is required to get the maximum efficiency of collector.

### **Concentrating Collectors**

Concentrating collector is a device to collect solar energy with high intensity of solar radiation on the energy absorbing surface. Such collectors use optical system in the form of reflectors or refractors.

These collectors are used for medium ( $100\text{-}300^\circ\text{C}$ ) and high-temperature (above  $300^\circ\text{C}$ ) applications such as steam production for the generation of electricity. The high temperature is achieved at absorber because of reflecting arrangement provided for concentrating the radiation at required location using mirrors and lenses.

These collectors are best suited to places having more number of clear days in a year.

The area of the absorber is kept less than the aperture through which the radiation passes, to concentrate the solar flux. These collectors require tracking to follow the sun because of optical system. The tracking rate depends on the degree of concentration ratio and needs frequent adjustment for system having high concentration ratio. The efficiency of these collectors lies between 50-70%. The collectors need more maintenance than FPC because of its optical system. The concentrating collectors are classified on the basis of reflector used; concentration ratio and tracking method adopted.

## **FPC with Reflectors**

The mirrors are placed as reflecting surface to concentrate more radiations on FPC absorber. The fluid temperature is higher by 30°C than achieved in FPC. These collectors utilize direct and diffuse radiation.

### **Lens Focusing Type**

The Fresnel lenses are used to concentrate the radiation at its focus. The lower side of lenses is grooved so that radiation concentrates on a focus line.

### **Compound Parabolic Collectors**

These collectors are line focusing type. The compound parabolic collectors have two parabolic surfaces to concentrate the solar radiation to the absorber placed at bottom. These collectors have high concentration ratio and concentrator is moving to track the sun.

### **Cylindrical Parabolic Collectors**

The troughs concentrate sunlight onto a receiver tube, placed along the focal line of the trough. The temperature at the absorber tube is obtained at nearly 400° C. The absorber in these collectors is moving to receive the reflected radiations by reflector, while the concentrators (trough) remains fixed. Because of its parabolic shape, it can focus the sun at 30 to 100 times its normal intensity (concentration ratio) on a receiver. The heat transfer medium carries the heat at one central place for further utilization.

### **Parabolic Dish Collector:**

The collectors have mirror-like reflectors and an absorber at the focal point. These collectors are point focusing type. The concentrating ratio of these collectors is 100 and temperature of the receiver can reach up to 2000° C. These collectors have higher efficiency for converting solar energy to electricity in the small-power plant. In some systems, a heat engine, such as a Stirling engine, is connected to the receiver to generate electricity.

### **Center Receiver Type (Solar Power Tower):**

These collectors are used to collect the large solar energy at one point. This system uses 100-10000 of flat tracking mirror scaled heliostats to reflect the solar energy to central receiver mounted on tower. The energy can be concentrated as much as 1,500 times than that of the energy coming in, from the sun. The losses of energy from the system are minimized as solar energy is being directly transferred by reflection from the heliostats to a single receiver where the sun's rays heat a fluid to produce steam.

### **Advantages of concentrating collector over flat collector**

The size of the absorber can be reduced that gives high concentration ratio.

- Thermal losses are less than FPC. However small losses occur in the concentrating collector because of its optical system as well as by reflection, absorption by mirrors and lenses. The efficiency increases at high temperatures.
- In these collectors the area intercepting the solar radiation is greater than the absorber area. These collectors are used for high-temperature applications.
- Reflectors can cost less per unit area than flat plate collectors.
- Focusing or concentrating systems can be used for electric power generation when not used for heating or cooling.
- Little or no anti freeze is required to protect the absorber in a concentrator system whereas the entire solar energy collection surface requires anti freeze protection in a flat plate collector

Disadvantages:

- Out of the beam and diffuse solar radiation components, only beam component is collected in case of focusing collectors because diffuse component cannot be reflected and is thus lost.
- In some stationary reflecting systems it is necessary to have a small absorber to track the sun image; in others the reflector may have to be adjustable more than one position if year round operation is desired; in other words costly orienting systems have to be used to track the sun.
- Additional requirements of maintenance particular to retain the quality of reflecting surface against dirt, weather, oxidation etc.
- Non –uniform flux on the absorber whereas flux in flat-plate collectors is uniform.
- Additional optical losses such as reflectance loss and the intercept loss, so they introduce additional factors in energy balances.

### **Solar Air Heaters**

Air stream is heated by the back side of the collector plate in flat plate collector. Fins attached to the plate increase the contact surface. The back side of the collector is heavily insulated with mineral wool or some other material. If the size of collector is large, a blower is used to draw air into the collector and transmit the hot air to dryer.

The most favorable orientation of a collector for heating only is facing due south at an inclination angle to the horizontal equal to the latitude plus 15°. The use of air as the heat transport fluid eliminates both freezing and corrosion problems and small air leaks are of less concern than water leaks

Disadvantages:

- Need of handling larger volumes of air than liquids due to low density of air as working substance. Thermal capacity of the air is low.
- They have relatively high fluid circulation costs (especially if the rock heat storage unit is not carefully designed)

- They have relatively large volumes of storage (roughly three times as much volume as for waterheat-storage)
- They have a higher noiselevel.
- The system has difficulty of adding conventional absorption air-conditioners to air systems
- The space is required for ducting.

#### Types of Air Heaters

Non porous absorber in which air stream does not flow through the absorber plate

Porous absorber that includes slit and expanded material, transpired honey comb and over lapped glass plate

Non-porous absorber plate type collectors: A non-porous absorber may be cooled by the air stream flowing over both sides of the plate. In most of the designs, the air flows behind the absorbing surface. Air flow above the upper surface increases the convection losses from the cover plate and therefore is not recommended if the air inlet temperature rise at the collector is large.

Transmission of the solar radiation through the transparent cover system and its absorption is identical to that of a liquid type flat-plate collector. To improve collection efficiency selective coating may be applied provided there is no much cost.

Due to low heat transfer rates, efficiencies are lower than liquid solar heaters under the same radiation intensity and temperature conditions. Performance of air heaters is improved by:

- Roughening the rear of the plate to promote turbulence and improve the convective heat transfer coefficient
  - Adding fins to increase heat transfer surface. Usually turbulence is also increased which enhances the convective heat transfer. Absorption of solar radiation is improved due to surface radioactive characteristics and the geometry of the corrugations, which help in trapping the reflected radiation.
2. Collectors with porous absorbers: The main drawback of the non-porous absorber plate is the necessity of absorbing all incoming radiation over the projected area from a thin layer over the surface.
  3. Efficiency cannot be improved. Too many surfaces and too much restriction to air flow will require a larger fan and a larger amount of energy to push the air through. The energy required for this cancels out saving from using solar energy, particularly if fan is electrical and if the amount of energy which is burned at the power plant to produce the electrical energy is included.
  4. The solar air heating utilizing a transpired honey comb is also favorable since the flow cross section is much higher. Crushed glass layers can be used to absorb solar radiation and heat the air. A porous bed with layers of broken bottles can be readily used for agricultural drying purposes with minimum expenditure. The overlapped glass plate air heater can be considered as a form of porous matrix, although overall flow direction is along the absorber plates instead of being across the matrix.

Applications of Solar air heaters

- Agricultural produce and lumber.
- Heating greenhouses.
- Air conditioning building utilizing desiccant beds or an absorption refrigeration process.
- Heat sources for a heat engine such as a Brayton or Stirling cycle.

### **Flat plate collector:**

Flat plate collector absorbs both beam and diffuse components of radiant energy. The absorber plate is a specially treated blackened metal surface. Sun rays striking the absorber plate are absorbed causing rise of temperature of transport fluid. Thermal insulation behind the absorber plate and transparent cover sheets (glass or plastic) prevent loss of heat to surroundings.

Applications of flat plate collector:

- Solar water heating systems for residence, hotels, industry.
- Desalination plant for obtaining drinking water from seawater.
- Solar cookers for domestic cooking.
- Drying applications.
- Residence heating.
- Losses in flat plate collector:

Shadow effect: Shadows of some of the neighbor panel fall on the surface of the collector where the angle of elevation of the sun is less than  $15^\circ$  (sun-rise and sunset). Shadow factor is less than 0.1 during morning and evening. The effective hours of solar collectors are between 9AM and 5PM.

Surface of the collector receiving light Total surface of the collection.

1. Cosine loss factor: For maximum power collection, the surface of collector should receive the sun rays perpendicularly. If the angle between the perpendicular to the collector surface and the direction of sun rays is  $\theta$ , then the area of solar beam intercepted by the collector surface is proportional to  $\cos\theta$ .

2. Reflective loss factor: The collector glass surface and the reflector surface collect dust, dirt, moisture etc. The reflector surface gets rusted, deformed and loses the shine. Hence, the efficiency of the collector is reduced significantly with passage of time.

3. Maintenance of flat plate collector:

- Daily cleaning
- Seasonal maintenance (cleaning, touch-up paint)
- Yearly overhaul (change of seals, cleaning after dismantling)

**Parabolic trough collector:**

Parabolic trough with line focusing reflecting surface provides concentration ratios from 30 to 50. Hence, temperature as high as 300°C can be attained. Light is focused on a central line of the parabolic trough. The pipe located along the centre line absorbs the heat and the working fluid is circulated through the pipe.

**Paraboloid dish collectors:**

The beam radiation is reflected by parabolic dish surface. The point focus is obtained with CR (above 1000) and temperatures around 1000°C.

Based on the temperature:

- Low temperature collector
- Medium temperature collector
- High temperature collector

Unglazed solar collectors are primarily used to pre-heat make-up ventilation air in commercial, industrial and institutional buildings with a high ventilation load. They turn building walls or sections of walls into low cost, high performance, unglazed solar collectors. Heat conducts from the absorber surface to the thermal boundary layer of air 1 mm thick on the outside of the absorber and to air that passes behind the absorber. The boundary layer of air is drawn into a nearby perforation before the heat can escape by convection to the outside air. The heated air is then drawn from behind the absorber plate into the building's ventilation system.

A Trombe wall is a passive solar heating and ventilation system consisting of an air channel sandwiched between a window and a sun-facing thermal mass. During the ventilation cycle, sunlight stores heat in the thermal mass and warms the air channel causing circulation through vents at the top and bottom of the wall. During the heating cycle the Trombe wall radiates stored heat.

Solar roof ponds are unique solar heating and cooling systems developed by Harold Hay in the 1960s. A basic system consists of a roof-mounted water bladder with a movable insulating cover. This system can control heat exchange between interior and exterior environments by covering and uncovering the bladder between night and day. When heating is a concern the bladder is uncovered during the day allowing sunlight to warm the water bladder and store heat for evening use. When cooling is a concern the covered bladder draws heat from the building's interior during the day and is uncovered at night to radiate heat to the cooler atmosphere.

Solar space heating with solar air heat collectors is more popular in the USA and Canada than heating with solar liquid collectors since most buildings already have a ventilation system for heating and cooling. The two main types of solar air panels are glazed and unglazed.

Solar drying

Solar thermal energy can be useful for drying wood for construction and wood fuels such as wood chips for

combustion. Solar is also used for food products such as fruits, grains, and fish. Crop drying by solar means is environmentally friendly as well as cost effective while improving the quality. The less money it takes to make a product, the less it can be sold for, pleasing both the buyers and the sellers. Technologies in solar drying include ultra low cost pumped transpired plate air collectors based on black fabrics. Solar thermal energy is helpful in the process of drying products such as wood chips and other forms of biomass by raising the temperature while allowing air to pass through and get rid of the moisture.

### Cooking

Solar cookers use sunlight for cooking, drying and pasteurization. Solar cooking offsets fuel costs, reduces demand for fuel or firewood, and improves air quality by reducing or removing a source of smoke. The simplest type of solar cooker is the box cooker first



## UNIT – III

### WIND ENERGY

The wind wheel, like the water wheel, has been used by man for a long time for grinding corn and pumping water. Ancient seamen used wind power to sail their ships. With the development of the fossil Characteristics of Wind Power

Wind as a source of energy is plentiful, inexhaustible and pollution free but it has the disadvantage that the degree and period of its availability are uncertain. Also, movement of large volumes of air is required, to produce even a moderate amount of power. As a result, the wind power must be used as and when it is available, in contrast to conventional methods where energy can be drawn upon when required. Wind power, therefore, is regarded as a means of saving fuel, by injection of power into an electrical grid, or run wind power plant in conjunction with a pumped storage plant. The power that can be theoretically obtained from the wind, is proportional to the cube of its velocity and thus high wind velocities are most important. The power developed using this law, in atmospheric condition where the density of air is  $1.2014 \text{ kg/cu meter}$ , is given as  $\text{Power developed} = 13.14 \times 10^{-6} A V^3 \text{ KW}$  where A is the swept area in sq. meter and V the wind velocity in Km/hr

A wind turbine is the popular name for a device that converts kinetic energy from the wind into electrical power.

#### **Betz Law**

**Betz's law** calculates the maximum power that can be extracted from the wind, independent of the design of a wind turbine in open flow. It was published in 1919, by the German physicist Albert Betz. The law is derived from the principles of conservation of mass and momentum of the air stream flowing through an idealized actuator disk that extracts energy from the wind stream. According to Betz's law, no turbine can capture more than  $16/27$  (59.3%) of the kinetic energy in wind. The factor  $16/27$  (0.593) is known as Betz's coefficient. Practical utility-scale wind turbines achieve at peak 75% to 80% of the Betz limit

#### **Classification of WEC system**

Several types of wind wheels have been used but the advantage of propeller rotating about a horizontal shaft, in a plane perpendicular to the direction of the wind make it the most likely type to realize economic generation on a large scale. A propeller consisting of two or three blades (with an aero foil section) and capable of running at the high speed is likely to be the most efficient. Present technology has been able to build systems with 60 m long blades, on towers as high as 305 m. A large tower system, to support many small rotor-generator units, can also be built.

**Horizontal-axis wind turbines (HAWT)** have the main rotor shaft and electrical generator at the top of a tower, and must be pointed into the wind. Small turbines are pointed by a simple wind vane, while large turbines generally use a wind sensor coupled with a servo motor. Most have a gearbox, which turns the slow rotation of the blades into a quicker rotation that is more suitable to drive an electrical generator.

**Vertical-axis wind turbines (VAWTs)** are a type of wind turbine where the main rotor shaft is set transverse, not

necessarily vertical, to the wind and the main components are located at the base of the turbine. This arrangement allows the generator and gearbox to be located close to the ground, facilitating service and repair. Wind pressure rotates the wind vanes or propellers attached to a shaft. The revolving shaft rotates the rotor of a generator, through a mechanism of gears couplings etc.

Thus, electricity is generated.

The wind power plants can be operated in combination with steam or hydro power station, which will lead to saving in fuel and increase in firm capacity, respectively of these plants. Wind energy can prove to be a potential source of energy for solving the energy problem. It can certainly go a long way to supply pollution-free energy to millions of people, living in the villages all over the world.

The economic viability of wind mills is better in situations where conventional transmission costs are extremely high (because of inaccessibility and small load) or where continuous availability of supply is not essential so that only a limited amount of storage on standby power need be provided.

## **BIO-MASS**

Biomass is biological material derived from living, or recently living organisms. It most often refers to plants or plant-derived materials which are specifically called lignocelluloses biomass. As an energy source, biomass can either be used directly via combustion to produce heat, or indirectly after converting it to various forms of biofuel. Conversion of biomass to biofuel can be achieved by different methods which are broadly classified into: thermal, chemical, and biochemical methods.

Biogas is produced as landfill gas (LFG), which is produced by the breakdown of biodegradable waste inside a landfill due to chemical reactions and microbes, or as digested gas, produced inside an anaerobic digester. A biogas plant is the name often given to an anaerobic digester

that treats farm wastes or energy crops. It can be produced using anaerobic digesters (air-tight tanks with different configurations). These plants can be fed with energy crops such as maize silage or biodegradable wastes including sewage sludge and food waste. During the process, the microorganisms transform biomass waste into biogas (mainly methane and carbon dioxide) and digestate. The biogas is a renewable energy that can be used for heating, electricity, and many other operations that use a reciprocating internal combustion engine. Other internal combustion engines such as gas turbines are suitable for the conversion of biogas into both electricity and heat. The digestate is the remaining organic matter that was not transformed into biogas. It can be used as an agricultural fertilizer.

Biogas is characterized based on its chemical composition and the physical characteristics which result from it. It is primarily a mixture of methane (CH<sub>4</sub>) and inert carbonic gas (CO<sub>2</sub>). However, the name "biogas" gathers a large variety of gases resulting from specific treatment processes, starting from various organic waste - industries, animal or domestic origin waste etc.

## **Biomass conversion technologies**

Thermal conversion processes use heat as the dominant mechanism to convert biomass into another chemical form. Energy created by burning biomass (fuel wood) is particularly suited for countries where the fuel wood grows more rapidly, e.g. tropical countries.

### **Biochemical conversion**

As biomass is a natural material, many highly efficient biochemical processes have developed in nature to break down the molecules of which biomass is composed, and many of these biochemical conversion processes can be harnessed. Biochemical conversion makes use of the enzymes of bacteria and other microorganisms to break down biomass. In most cases, microorganisms are used to perform the conversion process: anaerobic digestion, fermentation, and composting.

Anaerobic digestion is a collection of processes by which microorganisms break down biodegradable material in the absence of oxygen.

Fermentation is a metabolic process that converts sugar to acids, gases, and/or alcohol. It occurs in yeast and bacteria.

**Pyrolysis:** Pyrolysis is a thermochemical decomposition of organic material at elevated temperatures in the absence of oxygen (or any halogen). It involves the simultaneous change of chemical

composition and physical phase, and is irreversible. The word is coined from the Greek-derived elements pyro "fire"

### **Types of Biogas Plants**

A total of seven different types of biogas plant have been officially recognized by the MNES.

1. The floating-drum plant with a cylindrical digester (KVIC model),
2. The fixed-dome plant with a brick reinforced, moulded dome (Janata model),
3. The floating-drum plant with a hemisphere digester (Pragati model).
4. The fixed-dome plant with a hemisphere digester (Deenbandhu model).
5. The floating-drum plant made of angular steel and plastic foil (Ganesh model).
6. The floating-drum plant made of pre-fabricated reinforced concrete compound units.
7. The floating-drum plant made of fibre-glass reinforced polyester.

## **Types of Wind Turbines**

Modern wind turbines fall into two basic groups: the horizontal-axis variety, as shown in the photo, and the vertical-axis design, like the eggbeater-style Darrieus model, named after its French inventor. Horizontal-axis wind turbines typically either have two or three blades. These three-bladed wind turbines are operated "upwind," with the blades facing into the wind. GE Wind Energy's 3.6 megawatt wind turbine is one of the largest prototypes ever erected. Larger wind turbines are more efficient and cost effective.



## **Sizes of Wind Turbines**

Utility-scale turbines range in size from 100 kilowatts to as large as several megawatts. Larger turbines are grouped together into wind farms, which provide bulk power to the electrical grid.

Single small turbines, below 100 kilowatts, are used for homes, telecommunications dishes, or water pumping. Small turbines are sometimes used in connection with diesel generators, batteries, and photovoltaic systems. These systems are called hybrid wind systems and are typically used in remote, off-grid locations, where a connection to the utility grid is not available.

## **Inside the Wind Turbine:**

### **Anemometer:**

Measures the wind speed and transmits wind speed data to the controller.

### **Blades:**

Most turbines have either two or three blades. Wind blowing over the blades causes the blades to "lift" and rotate.

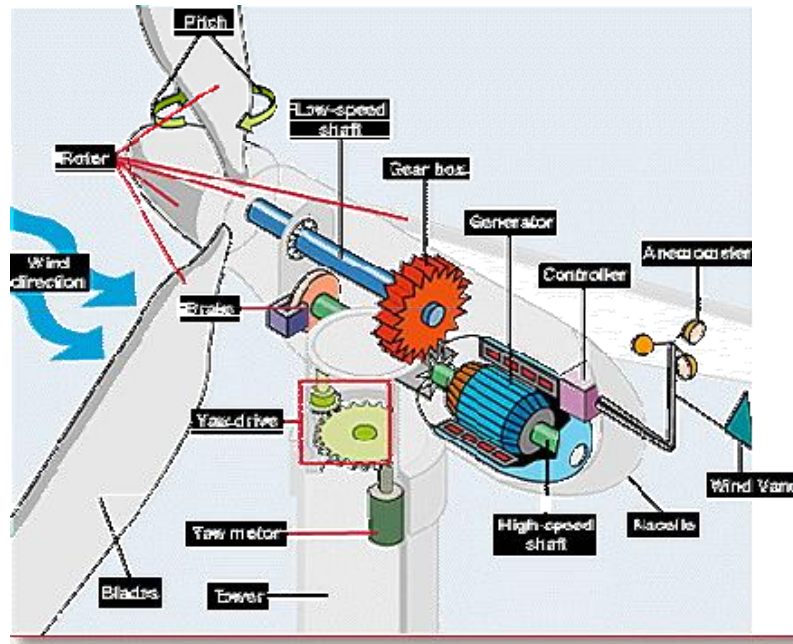

**Brake:**

A disc brake, which can be applied mechanically, electrically, or hydraulically to stop the rotor in emergencies.

**Controller:**

The controller starts up the machine at wind speeds of about 8 to 16 miles per hour (mph) and shuts off the machine at about 55 mph.

Turbines do not operate at wind speeds above about 55 mph because they might be damaged by the high winds.

**Gear box:**

Gears connect the low-speed shaft to the high-speed shaft and increase the rotational speeds from about 30 to 60 rotations per minute (rpm) to about 1000 to 1800 rpm, the rotational speed required by most generators to produce electricity. The gear box is a costly (and heavy) part of the wind turbine and engineers are exploring "direct-drive" generators that operate at lower rotational speeds and don't need gear boxes.

**Generator:**

Usually an off-the-shelf induction generator that produces 60-cycle AC electricity.

**High-speed shaft:**

Drives the generator.

**Low-speed shaft:**

The rotor turns the low-speed shaft at about 30 to 60 rotations per minute.

**Nacelle:**

The nacelle sits atop the tower and contains the gear box, low- and high-speed shafts, generator, controller, and brake. Some nacelles are large enough for a helicopter to land on.

**Pitch:**

Blades are turned, or pitched, out of the wind to control the rotor speed and keep the rotor from turning in winds that are too high or too low to produce electricity.

**Rotor:**

The blades and the hub together are called the rotor.

**Tower:**

Towers are made from tubular steel (shown here), concrete, or steel lattice. Because wind speed increases with height, taller towers enable turbines to capture more energy and generate more electricity.

**Wind direction:**

This is an "upwind" turbine, so-called because it operates facing into the wind. Other turbines are designed to run "downwind," facing away from the wind.

**Wind vane:**

Measures wind direction and communicate with the yaw drive to orient the turbine properly with respect to the wind.

**Yaw drive:**

Upwind turbines face into the wind; the yaw drive is used to keep the rotor facing into the wind as the wind direction changes. Downwind turbines don't require a yaw drive, the wind blows the rotor downwind.

**Yaw motor:**

Powers the yaw drive.

## UNIT IV

### GEOTHERMAL ENERGY

Many geothermal power plants are operating throughout the world. The earth's interior is made of a hot fluid called „magma“. The outer crust of the earth has an average thickness of 32 Km and below that, is the magma. The average increase in temperature with depth of the earth is 1°C for every 35 to 40 metre depth. At a depth of 3 to 4 Kms, water boils up and at a depth of about 15 Kms, the temperature is, in the range of 1000°C to 1200°C. If the magma finds its way through the weak spots of the earth's crust, it results into a volcano. At times, due to certain reasons the surface water penetrates into the crust, where it turns into steam, due to intense heat, and comes out in the form of springs or geysers. Moreover, the molten magma also contains water, which it releases in the form of steam, which could be utilized for electric power generation.

#### Classes of geo-thermal region

1. Hyper thermal
  - a) Temp gradient  $>800^{\circ}\text{C}$
  - b) Usually Tectonic PlateBoundaries
2. Semi-thermal
  - a) Temp gradient  $\sim 40^{\circ}\text{C km}^{-1}$  to  $80^{\circ}\text{Ckm}^{-1}$
  - b) Associated with anomalies away from plateboundaries.

#### Categories of of geo-thermal region

Hydro thermal convective systems

1. Vapour Dominated or Dry Steamfields
2. Liquid dominated system or wet steamfields
3. Hot Water fields
4. Geo pressuresources
5. Petr thermal or hot dry rocks(hdr)
6. Magmasources
7. Volcanoes

Hydro thermal Convective systems are best resources for geo-thermal

#### OCEAN ENERGY

**Ocean energy** refers to the energy carried by ocean waves,tides,salinity, and ocean temperaturedifferences. The movement of water in the world's oceans creates a vast store of kinetic energy, or energy in motion. This energy can be harnessed to generate electricity to power homes, transport and industries.

## **Ocean thermal energy conversion (OTEC)**

**OTEC** uses the temperature difference between cooler deep and warmer shallow or surface ocean waters to run a heat engine and produce useful work, usually in the form of electricity. OTEC is a base load electricity generation system. Systems may be either closed-cycle or open-cycle. Closed-cycle engines use working fluids that are typically thought of as refrigerants such as ammonia or R-134a. These fluids have low boiling points, and are therefore suitable for powering the system's generator to generate electricity. The most commonly used heat cycle for OTEC to date is the Rankine cycle using a low-pressure turbine. Open-cycle engines use vapor from the seawater itself as the working fluid.

## **Tidal power**

Tides are caused by the combined gravitational forces of Sun and Moon on the waters of the revolving Earth. When the gravitational forces due to the Sun and the Moon add together, tides of maximum range, called spring tides, are obtained. On the other hand, when the two forces oppose each other, tides of minimum range, called neap tides, are obtained. In one year there are approximately 705 full tidal cycles.

It has been suggested, that for harnessing tidal power effectively the most practicable method is the basin system. Here a portion of the sea is enclosed behind a dam or dams and water is allowed to run through turbines, as the tide subsides. The power available from a given head of water varies as the square of the head and since the head varies with the tidal range, the power available at different sites from tidal energy shows very wide variation. Various tidal basin systems have, therefore, been evolved, in order to overcome this wide variation in availability of tidal power.

## **Single Basin System**

The simplest scheme for developing tidal power is the single basin arrangement, in which a single basin of constant area is provided with sluices (gates), large enough to admit the tide, so that the loss of head is small. The level of water in the basin is the same as that of the tide outside. When the tides are high, water is stored in the basin and sluice gates are closed. When the tides are falling, sluices are opened to allow water to go through the turbine to generate power. A head of water is obviously required for the turbine to generate power. This continues to generate power till the level of the falling tides coincides with the level of the next rising tide.

The major disadvantage of this single basin scheme is that it gives intermittent supply of power, varying considerably over the period of operation. It is for this reason that the tidal power has not been developed on a large scale. Also with this scheme, only about 50 per cent of tidal energy is available.

## **Two Basin Systems**



An improvement over the single basin system is the two-basin system. In this system, a constant and continuous output is maintained by suitable adjustment of the turbine valves to suit the head under which these turbines are operating.

A two-basin system regulates power output of an individual tide but it cannot take care of the great difference in outputs between spring and neap tides. This system, therefore, provides a partial solution to the problem, of getting a steady output of power from a tidal scheme.

This disadvantage can be overcome by the joint operation of tidal power and pumped storage plant. During the period when the tidal power plant is producing more energy than required, the pumped storage plant utilizes the surplus power for pumping water to the upper reservoir. When the output of the tidal power plant is low, the pumped storage plant generates electric power and feeds it to the system. This arrangement, even though technically feasible, is much more expensive, as it calls for higher installed capacity for meeting a load.

This basic principle of joint operation of tidal power with steam plant, is also possible when it is connected to a grid. In this case, whenever tidal power is available, the output of the steam plant will be reduced by that extent which leads to saving in fuel and reduced wear and tear of steam plant. This operation requires the capacity of steam power plant to be equal to that of tidal power plant and makes the overall cost of power obtained from such a combined scheme very high. In the system the two basins close to each other, operate alternatively. One basin generates power when the tide is rising (basin getting filled up) and the other basin generates power while the tide is falling (basin getting emptied). The two basins may have a common power house or may have separate power house for each basin. In both the cases, the power can be generated continuously. The system could be thought of as a combination of two single basin systems, in which one is generating power during tiding cycle, and the other is generating power during emptying.

### **Double Basin System**

This scheme consists of two basins, at different elevation connected through turbine. The sluices in the high and low level basin communicate with sea water directly. The high level basin sluices are called the inlet sluices and the low level as outlet sluices. The basic operation of the scheme is as follows.

### **Turbines for Tidal Power**

Tidal power plants operate using a rapidly varying head of water and, therefore, their turbines must have high efficiency at varying head. The Kaplan type of water turbine operates quite favorably under these conditions. The propeller type of turbine is also suitable because the angle of the blades can be altered to obtain maximum efficiency while water is falling.

### **WAVE POWER**

Another source of non-conventional energy generation is the wave power. The major problem with the wave

power is that it is not concentrated at a place. If means could be developed for collecting the energy in the wave, spread over a large surface area, and concentrating it into a relatively small volume, the prospects, would be considerably improved.

It has been observed that a typical wave measures 2 to 3 metres in height throughout the year. The energy per square metre of wave surface area is given as  $\frac{1}{2} \rho g a^2$  where  $\rho$  is density of sea water,  $g$  is acceleration due to gravity and  $a$  is the amplitude of the wave. In the Atlantic, the wave period  $T$  is around 9s, and the average velocity of propagation of wave is 14 m/s. It has been observed that a power flow of around 70 KW for every metre of wave front, can be obtained. This is a considerable amount of power, especially when we think of the availability of this power throughout the year. If the length of the coast line is, say 1200 Km, the power available is around 84 GW.

**Small hydro** is the development of hydroelectric power on a scale serving a small community or industrial plant. The definition of a small hydro project varies, but a generating capacity of up to 10 megawatts (MW) is generally accepted as the upper limit, which aligns to the concept of distributed generation. Hydroelectric power is the generation of electric power from the movement of water. A hydroelectric facility requires a dependable flow of water and a reasonable height of fall of water, called the head. In a typical installation, water is fed from a reservoir through a channel or pipe into a turbine. The pressure of the flowing water on the turbine blades causes the shaft to rotate. The rotating shaft is connected to an electrical generator which converts the motion of the shaft into electrical energy. Small hydro is often developed using existing dams or through development of new dams whose primary purpose is river and lake water-level control, or irrigation. Small hydro schemes may be tidal energy or propeller-type turbines immersed in flowing water to extract energy. Tidal schemes may require water storage or electrical energy storage to level out the intermittent (although exactly predictable) flow of power.

Since small hydro projects usually have minimal environmental and licensing procedures, and since the equipment is usually in serial production, standardized and simplified, and since the civil works construction is also small, small hydro projects may be developed very rapidly. The physically small size of equipment makes it easier to transport to remote areas without good road or rail access. Small hydro can be further subdivided into mini hydro, usually defined as less than 1,000 kilowatts (kW), and micro hydro which is less than 100 kW.

### **Generating methods**

The world's first commercial-scale and grid-connected tidal stream generator – SeaGen in Strangford Lough. The strong wake shows the power in the tidal current.

Top-down view of a DTP dam. Blue and dark red colors indicate low and high tides, respectively.

Tidal power can be classified into three generating methods:

#### **Tidal stream generator**

Tidal stream generators (or TSGs) make use of the kinetic energy of moving water to power turbines, in a similar way to wind turbines that use moving air.

#### **Tidal barrage**

Tidal barrages make use of the potential energy in the difference in height (or *head*) between high and low tides.

Barrages are essentially dams across the full width of a tidal estuary.

### **Dynamic tidal power**

Dynamic tidal power (or DTP) is a theoretical generation technology that would exploit an interaction between potential and kinetic energies in tidal flows. It proposes that very long dams (for example: 30–50 km length) be built from coasts straight out into the sea or ocean, without enclosing an area. Tidal phase differences are introduced across the dam, leading to a significant water-level differential in shallow coastal seas – featuring strong coast-parallel oscillating tidal currents such as found in the UK, China and Korea.

### **PUMPED STORAGE:**

**Pumped-storage hydroelectricity** is a type of hydroelectric power generation used by some power plants for *load balancing*. The method stores energy in the form of water, pumped from a lower elevation reservoir to a higher elevation. Low-cost off-peak electric power is used to run the pumps. During periods of high electrical demand, the stored water is released through turbines. Although the losses of the pumping process makes the plant a net consumer of energy overall, the system increases revenue by selling more electricity during periods of *peak demand*, when electricity prices are highest. Pumped storage is the largest-capacity form of grid energy storage now available.

### **SOLAR CENTRAL RECIVER SYSTEM:**

The **solar power tower** (also known as 'central tower' power plants or 'heliostat' power plants or power towers) is a type of solar furnace using a tower to receive the focused sunlight. It uses an array of flat, movable mirrors (called heliostats) to focus the sun's rays upon a collector tower (the target). Concentrated solar thermal is seen as one viable solution for renewable, pollution free energy production with currently available technology.

Early designs used these focused rays to heat water, and used the resulting steam to power a turbine. Newer designs using liquid sodium has been demonstrated, and systems using molten salts (40% potassium nitrate, 60% sodium nitrate) as the working fluids are now in operation. These working fluids have high heat capacity, which can be used to store the energy before using it to boil water to drive turbines. These designs allow power to be generated when the sun is not shining.

### **COST OF ELECTRICAL ENERGY:**

**Electric power transmission** or "high voltage electric transmission" is the bulk transfer of electrical energy, from generating power plants to substations located near to population centers. This is distinct from the local wiring between high voltage substations and customers, which is typically referred to as electricity distribution. Transmission lines, when interconnected with each other, become high voltage transmission networks. In the US, these are typically referred to as "power grids" or just "the grid", while in the UK the network is known as the "national grid." North America has three major grids: The Western Interconnection; The Eastern Interconnection and

the Electric Reliability Council of Texas (or ERCOT) grid.

Historically, transmission and distribution lines were owned by the same company, but over the last decade or so many countries have liberalized the electricity market in ways that have led to the separation of the electricity transmission business from the distribution business.

Transmission lines mostly use three-phase alternating current (AC), although single phase AC is sometimes used in railway electrification systems. High-voltage direct-current (HVDC) technology is used only for very long distances (typically greater than 400 miles, or 600 km); submarine power cables (typically longer than 30 miles, or 50 km); or for connecting two AC networks that are not synchronized.

Electricity is transmitted at high voltages (110 kV or above) to reduce the energy lost in long distance transmission. Power is usually transmitted through overhead power lines. Underground power transmission has a significantly higher cost and greater operational limitations but is sometimes used in urban areas or sensitive locations.

A key limitation in the distribution of electricity is that, with minor exceptions, electrical energy cannot be stored, and therefore must be generated as needed. A sophisticated system of control is therefore required to ensure electric generation very closely matches the demand. If supply and demand are not in balance, generation plants and transmission equipment can shut down which, in the worst cases, can lead to a major regional blackout, such as occurred in California and the US Northwest in 1996 and in the US Northeast in 1965, 1977 and 2003. To reduce the risk of such failures, electric transmission networks are interconnected into regional, national or continental wide networks thereby providing multiple redundant alternate routes for power to flow should (weather or equipment) failures occur. Much analysis is done by transmission companies to determine the maximum reliable capacity of each line which is mostly less than its physical or thermal limit, to ensure spare capacity is available should there be any such failure in another part of the network.

#### **ENERGY RATES:**

**Electricity pricing** (sometimes referred to as **electricity tariff** or the **price of electricity**) varies widely from country to country, and may vary significantly from locality to locality within a particular country. There are many reasons that account for these differences in price. The price of power generation depends largely on the type and market price of the fuel used, government subsidies, government and industry regulation, and even local weather patterns.

#### **Basis of electricity rates**

Electricity prices vary all over the world, even within a single region or power-district of a single country. In standard regulated monopoly markets, they typically vary for residential, business, and industrial customers, and for any single customer class, might vary by time-of-day or by the capacity or nature of the supply circuit (e.g., 5 kW, 12 kW, 18 kW, 24 kW are typical in some of the large developed countries); for industrial customers, single-phase vs. 3-phase, etc. If a specific market allows real-time dynamic pricing, a more recent option in only a few

markets to date, prices can vary by a factor of ten or so between times of low and high system-wide demand.

### **TYPES OF TARIFFS:**

In economic terms, electricity (both power and energy) is a commodity capable of being bought, sold and traded. An **electricity market** is a system for effecting purchases, through bids to buy; sales, through offers to sell; and short-term trades, generally in the form of financial or obligation swaps. Bids and offers use supply and demand principles to set the price. Long-term trades are contracts similar to power purchase agreements and generally considered private bi-lateral transactions between counterparties.

Wholesale transactions (bids and offers) in electricity are typically cleared and settled by the market operator or a special-purpose independent entity charged exclusively with that function. Market operators do not clear trades but often require knowledge of the trade in order to maintain generation and load balance. The commodities within an electric market generally consist of two types: Power and Energy. Power is the metered net electrical transfer rate at any given moment and is measured in Megawatts (MW). Energy is electricity that flows through a metered point for a given period and is measured in Megawatt Hours (MWh).

**Offshore Wave Energy.** An inventor approaches you with the design for a wave energy device that he claims will generate 50 GWh of energy annually. The device has a wave inlet 25 meters wide and converts wave energy to electricity by some secret process he won't reveal.

### **Barrage Tidal System:**

Barrage Tidal System currently, the only power you have at the cabin is a noisy and smelly gasoline generator that you would like to replace. On the shore of your island near your cabin is a natural cleft in the steep shoreline. If you build a low dam across the cleft at the proper height, the dam would be flooded at high tide, but would create a pool or lagoon behind it at low tide. If you install a pipe through the bottom of the dam with a simple turbine and generator, you could generate electricity on the ebb flow of the tide. You do some quick measurements and find that the area of the lagoon behind the dam would be about 5m wide by 20m long, and the lagoon would be about 3m deep at high tide, and 1m deep at low tide.

### **Renewable Energy Technologies and Applications**

The study focuses on concentrating solar thermal power generation because this is by far the greatest renewable energy resource in the EU-MENA region, but other renewable energy sources are represented as well, in order to obtain a well balanced mix of energies that can not only cope with the growing energy demand, but also with the needs of power security and grid stability. The renewable energy technology portfolio that was considered within the study is described in the following.

### **Concentrating Solar Thermal Power Technologies:**

Concentrating solar thermal power technologies (CSP) are based on the concept of concentrating solar radiation to be

used for electricity generation within conventional power cycles using steam turbines, gas turbines or Stirling engines. For concentration, most systems use glass mirrors that continuously track the position of the sun. The concentrated sunlight is absorbed on a receiver that is specially designed to reduce heat losses. A fluid flowing through the receiver takes the heat away towards the power cycle, where e.g. high pressure, high temperature steam is generated to drive a turbine. Air, water, oil and molten salt are used as heat transfer fluids

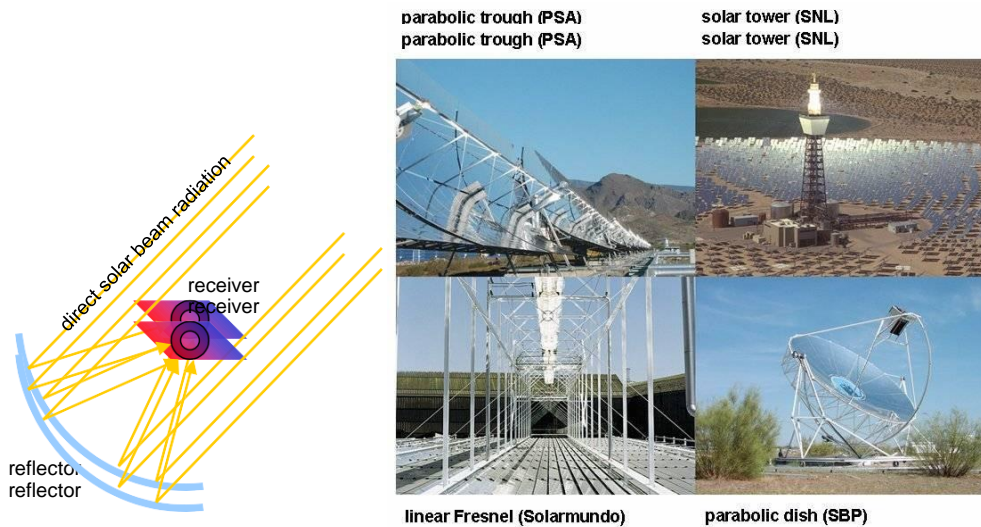

Fig: Principle of concentrating solar beam radiation and the four CSP collector technology main streams realized up to date

Parabolic troughs, linear Fresnel systems and power towers can be coupled to steam cycles of 5 to 200 MW of electric capacity, with thermal cycle efficiencies of 30 – 40 %. Dish-Stirling engines are used for decentralized generation in the 10 kW range. The values for parabolic troughs have been demonstrated in the field. Today, these systems achieve annual solar-to-electricity-efficiencies of about 10 – 15 %, with the perspective to reach about 18 % in the medium term (Table 2-1). The values for the other systems are based on component and prototype system test data and the assumption of mature development of current technology. The overall solar-electric efficiencies include the conversion of solar energy to heat within the collector and the conversion of the heat to electricity in the power block. The conversion efficiency of the power block remains basically the same as in fuel fired power plants.

Power towers can achieve very high operating temperatures of over 1000 °C, enabling them to produce hot air for gas turbine operation. Gas turbines can be used in combined cycles, yielding very high conversion efficiencies of the thermal cycle of more than 50 %.

Each of these technologies can be operated with fossil fuel as well as solar energy. This hybrid operation has the potential to increase the value of CSP technology by increasing its power availability and decreasing its cost by making more effective use of the power block. Solar heat collected during the daytime can be stored in concrete, molten salt, ceramics or phase-change media. At night, it can be extracted from the storage to run the power block. Fossil and renewable fuels like oil, gas, coal and biomass can be used for co-firing the plant, thus providing power capacity whenever required

Moreover, solar energy can be used for co-generation of electricity and process heat. In this case, the primary energy input is used with efficiencies of up to 85 %. Possible applications cover the combined production of industrial heat, district cooling and sea water desalination.

All concepts have the perspective to expand their time of solar operation to base load using thermal energy storage and larger collector fields. To generate one Megawatt-hour of solar electricity per year, a land area of only 4 to 12 m<sup>2</sup> is

required. This means, that one km<sup>2</sup> of arid land can continuously and indefinitely generate as much electricity as any conventional 50 MW coal - or gas fired power station.

Thus, two main characteristics make concentrating solar power a key technology in a future renewable energy supply mix in MENA:

- it can deliver secured power as requested by demand
- its natural resource is very abundant and practically unlimited

Their thermal storage capability and hybrid operation with fuels allows CSP plants to provide power on demand. Their availability and capacity credit is considered to be 90 %. CSP plants can be build from several kW to several 100 MW capacity.

- solarelectricity
- integrated backupcapacity, power ondemand
- increased solaroperating hours, reduced fuelinput
- additional process heatfor cooling, drying, seawater desalination,etc.

Figure 2-2: Principle of solar thermal co-generation of heat and power

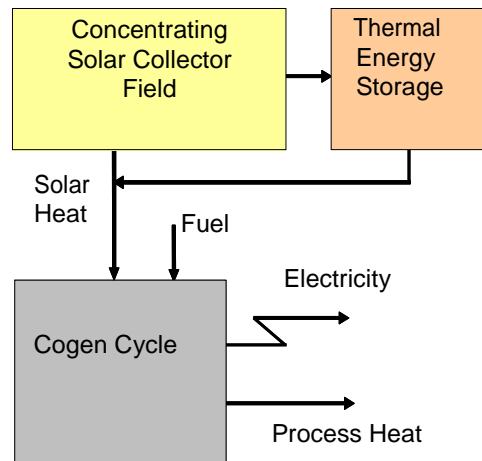

## UNIT – V

### DIRECT ENERGY CONVERSION

It is the method of transformation of one type of energy into another without passing through the intermediate stage such as steam, generators etc. Most of these energy converters, sometimes called static energy-conversion devices, use electrons as their “working fluid” in place of the vapor or gas employed by such dynamic heat engines as the external- combustion and internal- combustion engines mentioned above. In recent years, direct energy-conversion devices have received much attention because of the necessity to develop more efficient ways of transforming available forms of primary energy into electric power. Direct energy-conversion devices are of interest for providing electric power in spacecraft because of their reliability and their lack of moving parts. As have solar cells, fuel cells, and thermoelectric generators, thermionic power converters have received considerable attention for space applications. Thermionic generators are designed to convert thermal energy directly into electricity.

Direct Energy Conversion devices like thermionic and thermoelectric converters are heat engines the heat engine operates between two reservoirs to and from which heat can be transferred. We put heat into the system from the hot reservoir and heat is expelled in to the cold reservoir.

#### **The Carnot cycle**

The Carnot cycle is a theoretical thermodynamic cycle proposed by Nicolas Léonard Sadi Carnot. It can be shown that it is the most efficient cycle for converting a given amount of thermal energy into work, or conversely, creating a temperature difference (e.g. refrigeration) by doing a given amount of work.

Every single thermodynamic system exists in a particular state. When a system is taken through a series of different states and finally returned to its initial state, a thermodynamic cycle is said to have occurred. In the process of going through this cycle, the system may perform work on its surroundings, thereby acting as a heat engine. A system undergoing a Carnot cycle is called a Carnot heat engine, although such a "perfect" engine is only a theoretical limit and cannot be built in practice

The Carnot cycle when acting as a heat engine consists of the following steps:

- 1 Reversible isothermal expansion of the gas at the "hot" temperature,  $T_1$  (isothermal heat addition or absorption). During this step the gas is allowed to expand and it does work on the surroundings. The temperature of the gas does not change during the process, and thus the expansion is isothermal. The gas expansion is propelled by absorption of heat energy  $Q_1$  and of entropy  $\Delta S=Q_1/T_1$  from the high temperature reservoir.
- 2 Isentropic (reversible adiabatic) expansion of the gas (isentropic work output). For this step the mechanisms of the engine are assumed to be thermally insulated, thus they neither gain nor lose heat.

The gas continues to expand, doing work on the surroundings, and losing an equivalent amount of



internal energy. The gas expansion causes it to cool to the "cold" temperature,  $T_2$ . The entropy remains unchanged.

3. Reversible isothermal compression of the gas at the "cold" temperature,  $T_2$ . (isothermal heat rejection) Now the surroundings do work on the gas, causing an amount of heat energy  $Q_2$  and of entropy  $\Delta S=Q_2/T_2$  to flow out of the gas to the low temperature reservoir. (This is the same amount of entropy absorbed in step 1, as can be seen from the Clausius inequality.)
4. Isentropic compression of the gas (isentropic work input). Once again the mechanisms of the engine are assumed to be thermally insulated. During this step, the surroundings do work on the gas, increasing its internal energy and compressing it, causing the temperature to rise to  $T_1$ . The entropy remains unchanged. At this point the gas is in the same state as at the start of step 1.

### **Principles of DEC**

Converts the heat energy into electrical energy based on the principles of Seebeck effect. Later, in 1834, French scientist, Peltier and in 1851, Thomson (later Lord Kelvin) described the thermal effects on conductors

#### **Seebeck effect**

When the junctions are produced in two different metals are maintained at different the circuit. This is known as Seebeck effect.

#### **Peltier effect**

Whenever current passes through the circuit of two dissimilar conductors, depending on the current direction, either heat is absorbed or released at the junction of the two conductors. This is known as Peltier effect

#### **Thomson effect**

Heat is absorbed or produced when current flows in material with a certain temperature gradient. The heat is proportional to both the electric current and the temperature gradient. This is known as Thomson effect

#### **Thermoelectric effect**

The thermoelectric effect, is the direct conversion of heat differentials to electric voltage and vice versa the good thermoelectric materials should possess large Seebeck coefficients, high electrical conductivity and low thermal conductivity

MHD – or MagnetoHydroDynamics – is a little known and under-exploited branch of physics discovered by Faraday over 100 years ago. The related phenomena of generative and motive forces are well known and aren't exotic in the least; they are in fact very simple to reproduce and utilize. Known applications of MHD include the Tokamak and other experimental hot fusion devices, a solid-state submarine propulsion system, the Ionic Breeze air filter and other obscure inventions. Our particular system relies on focused solar energy to heat and pressurize a unique medium.

It is claimed that the design described herein is the perfect blend of solar and MHD technologies and will

maximize both of these ideal conversion methods. In Solar Energy less attention has been given to collector technologies; instead, Photovoltaic cells with efficiency no greater than most fossil fuels have been adopted. This is reasonable since there have only been a few methods of using the solar focus. In Plasma physics, MHD generators have taken a back seat to Hot Fusion that requires even more insane temperatures. Through refinement of all components and aspects, our conceptual fusion will prove to be superior.

## UNFAIR ADVANTAGES

In comparison to Photovoltaic Solar Cells, our system is far more efficient, not only in terms of manufacturing but also because it maximizes the potential of focused sunlight (from an equivalent area) to the highest degree possible – it simultaneously converts light into heat *and* electricity

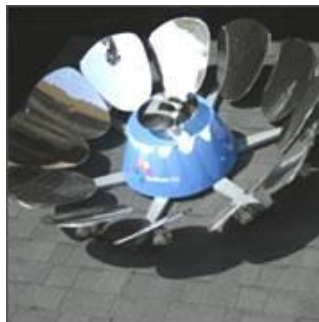

The Sunflower 250:

In contrast to the nearest competitor IP, Innovative Energy's Sunflower 250, our system is far more efficient because our system utilizes three different means of tapping the sunlight as opposed to one Stirling engine. Another thing to consider as well is that our hydraulic/rotary system is always going to be more efficient than a pneumatic/piston system.

## SUPERIOR PERFORMANCE ASPECTS

Uses new proprietary medium better than Plasma or LiquidMetal

- Harnesses solar focus three ways (MHD Induction, Turbine, Heat)
- Uses variable combinations of forces to generate electricity
  - expansion of working fluid
  - convection
  - magneto-caloric pumping
  - induction

## Renewable Energy Technology Options for Europe and MENA

The market potential of CSP plants must be seen in the context of other renewable energy technologies for power generation. In the following we show those options and how they are modelled within the study (Figure 2-3). A description of each technology can be found in /BMU 2004-3/.

WindPower(Enercon)



Hydropower(Tauernkraft)



Solar Chimney(SBP)

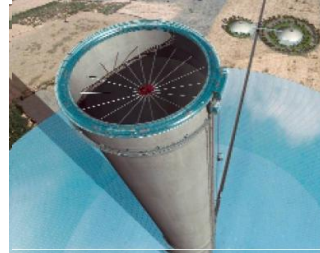

Photovoltaic(NREL)

Hot Dry Rock(StadtwerkeUrach)

Biomass Power(NREL)

Fig: Renewable energy technologies considered in the MED-CSP study in addition to concentrating solar thermal power plants

### Wind Power

Wind power can be generated in distributed wind power plants of up to 5 MW capacity each, or in large wind parks interconnecting tens or even hundreds of such plants. There are onshore and offshore wind parks, build into the sea where it is not deeper than 40 m. Wind power is typically fluctuating and cannot be delivered on demand. Wind power is stored for some seconds in the rotating mass of the wind turbines or as chemical or mechanical energy in batteries or large pump storage systems. There are also investigations on storing wind power in form of pressurized air. Fluctuations of the wind

Velocity is only correlated within a few kilometers of distance. Therefore, the fluctuations of a number of wind mills spread over a large area will usually compensate each other to some extent, leading to power supply transients that are quite manageable by the rest of the power park. However, their share on secured power capacity (capacity credit) is only between 0 and maximum 30 % of their installed capacity in very good areas with continuous trade winds /EWEA

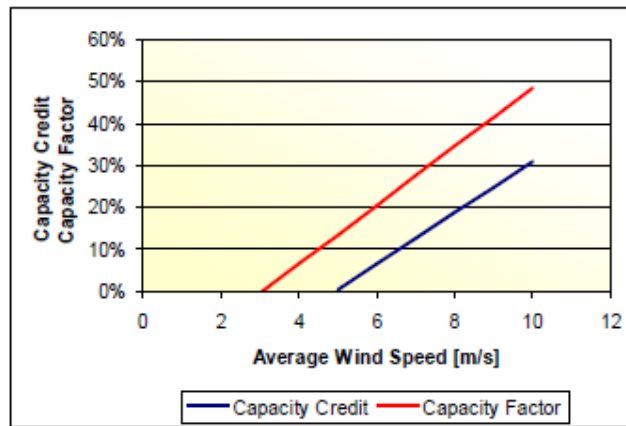

The technical performance of large wind power parks is modeled by the functions shown in Figure 2- 4 that define their overall annual full load hours and their annual electricity yield. Even under optimum conditions with an average wind speed of 10 m/s, a large wind park will deliver only 50% of its capacity over the year, and only 30 % as secured continuous contribution.

The electricity yield  $E_{wind}$  from wind power plants is calculated with the following equation, taking into consideration the capacity factor of the wind power park that is approximately a function of the average annual wind speed as shown in Figure

$$E_{wind} = P_{wind} \cdot CF_{wind} \cdot 8760 \text{ h/y}$$

$E_{wind}$  Annual electricity yield from wind power [MWh/y]

$CF_{wind}$  Capacity factor as function of the average annual wind speed

$P_{wind}$  Installed wind power capacity [MW]

8760 represents the total hours per year

### Photovoltaic Power

PV systems are typically used for distributed or remote power systems with or without connection to the utility grid. Their capacity ranges from a few Watt to several MW. Batteries are usually applied in smaller decentralized supply systems to store the solar energy over the night. There are also scenarios for very large PV systems up to 1.5 GW each to be built in desert areas until 2050 /IEA 2003-1/. Both small and large scale options have been included in the MED-CSP scenario, but only grid connected PV has been quantified in the renewable electricity mix. The electricity yield of PV systems is modeled as function of the global irradiance on a surface tilted at the respective latitude angle. PV cannot offer any secured capacity. Backup capacity must be provided by other technologies within the grid. Energy from very large PV could be stored in pump storage systems. The annual capacity factor and the annual full load hours are defined by the annual solar irradiance and the relation of the annual mean system efficiency to the layout efficiency (q-factor). The q-factor is today typically 0.67 and expected to become 0.85 in the year 2050. This results

in the performance functions shown for different annual irradiances in Figure.

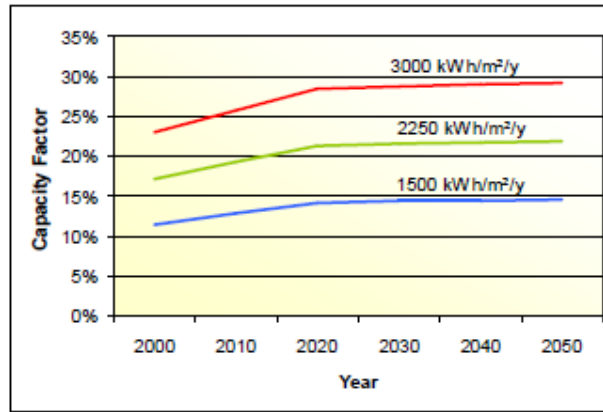

Figure 2-5: Capacity factor of grid-connected PV systems as function of global irradiance on a surface tilted at latitude angle and year of commissioning. There is no capacity credit for PV-power.

The electricity yield  $E_{PV}$  from photovoltaic systems is calculated with the following equation, taking into consideration the capacity factor of the PV power plants that is a function of the average annual irradiance on a tilted surface as shown in Figure.

$$E_{PV} = P_{PV} \cdot CF_{PV} \cdot 8760 \text{ h/y}$$

$$CF_{PV} = q_{PV} \cdot GTI \cdot P_{PV} \cdot A_{PV} / 8760 \text{ h/y}$$

$E_{PV}$  Annual electricity yield from photovoltaics [kWh/y]

$CF_{PV}$  Capacity factor as function of the annual global irradiance  $P_{PV}$  Installed photovoltaic power capacity [kW]

$q_{PV}$  annual system efficiency / standard design efficiency

$GTI$  Global irradiance on a tilted surface [kWh/m²/y]

$P_{PV}$  Annual PV system efficiency in first year (assumed as  $\eta_{PV} = 0.1$ )

$A_{PV}$  Design collector area for standard efficiency [m²/kW] ( $A_{PV} = 10 \text{ m}^2/\text{kW}$ ) 8760

### Geothermal Power (Hot Dry Rocks):

Geothermal heat of over 200 °C can be delivered from up to 5000 m deep holes to operate organic Rankine cycles or Kalina cycle power machines. Unit sizes are about 1 MW today and limited to about 100 MW maximum in the future. Geothermal energy is often used for the co-generation of heat and power. Geothermal power plants are used all over the world where surface near geothermal hot water or steam sources are available, like in USA, Italy and the Philippines. In the MED-CSP study region those conventional geothermal potentials are significant in Island, Italy, Turkey, Yemen and Iran. Those potentials are small in comparison to the HDR potentials and are not quantified separately in the study. The Hot Dry Rock technology aims to make geothermal potentials available everywhere, drilling deep holes into the ground to inject cold water and receive hot water from cooling down the hot rocks in the depth /IGA 2004/. However, this is a very new though promising approach and technical feasibility must still be proven. Geothermal power plants provide power on demand using the ideal storage of the earth's hot interior as a reservoir. They can provide peak load, intermediate load or base load electricity. Therefore, the capacity factor of geothermal plants is defined by the load and their operation mode. Assuming a plant availability of 90 %, their capacity credit would have that same value.

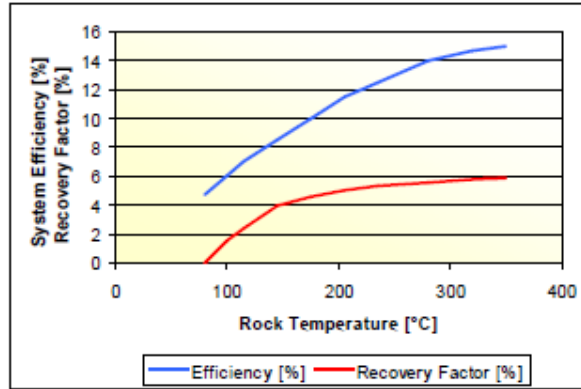

The available heat in place  $E_{th}$  is calculated as a function of the volume of rocks that will be affected by the cooling process /TAB 2003/. From that, the extractable geothermal electricity per year  $E_{geo}$  can be calculated as a function of the power cycle efficiency, the recovery factor and the total time of extraction. The recovery factor takes into account that only a small part of the affected rock volume is cooled down, and that the lower cycle temperature is higher than the surface temperature.

$$E_{th} = c_G \cdot \rho_G \cdot V \cdot (T_{5000} - T_{surface})$$

$$E_{th} \cdot R \cdot \eta / t_{extract}$$

$E_{th}$  Heat in place [J]

$E_{el}$  Extractable geothermal electricity [J/y]

$c_G$  Specific heat of the rocks [J/kg K]

$\rho_G$   
Density of the rocks [kg/m<sup>3</sup>] V

Density of the

affected [m<sup>3</sup>]

Volume of rock

$T_{5000}$

Temperature of the rocks at 5000m

depth [°C]  $T_{surface}$  Surface Temperature [°C]

R Recovery Factor

$\eta$

System

$t_{extract}$  Extraction

Extraction

action time [y]

For the study we have made the following assumptions:

$$c_G = 840 \text{ [J/kg}\cdot\text{K]}, \rho_G = 2600 \text{ kg/m}^3, T_S = 10^\circ\text{C}, V = 1 \text{ km}^3, t_{\text{extract}} = 1000 \text{ years}$$

### Biomass Power (Waste and Wood)

There are a number of potential sources to generate energy from biomass: biogas can be produced by the decomposition of organic materials like municipal liquid waste, manure or agricultural residues. Biogas reactors usually require large quantities of water. The calorific value of biogas is about 6 kWh/m<sup>3</sup>. Biogas can be used in combustion engines or turbines for electricity generation and for co-generation of heat and power. Landfill gas can be used in a similar way.

Solid biomass from agricultural or municipal residues like straw or bagasse and from wood can be used to generate heat and power. From every ton of solid biomass about 1.5 MWh of heat or 0.5 MWh of electricity can be generated in steam cycle power plants.

There is also the possibility to raise energy crops. However, this option has been neglected in the MENA region due to their competition with food crops and the severe water supply situation.

The size of biomass plants ranges from some kW (combustion engines) to about 25 MW. Biomass can be stored and consumed on demand for power generation. However, there are often seasonal restrictions to the availability of biomass. Typical plants have capacity factors between 0.4 and 0.6 that are equivalent to 3500 – 5500 full load hours per year. They are usually operated to provide intermediate or peaking power but seldom for base load. The availability of biomass plants is high at 90% and so is their capacity credit. This credit can be lower if the plants are used for co-generation of heat and power and if heat is the primary product. Electricity generation from biomass is calculated with the following equations:

$$E_{\text{bio}} = E_{\text{mun}} + E_{\text{agr}} + E_{\text{wood}}$$

$$E_{\text{mun}} = N \cdot w_{\text{mun}} \cdot e_{\text{bio}}$$

$$E_{\text{agr}} = w_{\text{agr}} \cdot e_{\text{bio}}$$

$$E_{\text{wood}} = p_{\text{wood}} \cdot A_{\text{forest}} \cdot e_{\text{bio}}$$

$$E_{\text{bio}} \quad \text{Electricity from biomass [MWh/y]}$$

$$E_{\text{mun}} \quad \text{Electricity from municipal waste [MWh/y]} \quad E_{\text{agr}} \quad \text{Electricity from agricultural residues [MWh/y]} \quad E_{\text{wood}} \quad \text{Electricity from wood [MWh/y]}$$

$$e_{\text{bio}} \quad \text{Specific electricity yield from biomass [MWh/ton]}$$

$$w_{\text{mun}} \quad \text{Specific municipal waste production per capita [tons/capita/year]} \quad w_{\text{agr}} \quad \text{Agricultural waste production [tons/year]}$$

$$p_{\text{wood}} \quad \text{Specific wood production per area [tons/ha/year]}$$

Biomass productivity [tons/ha/year]  $A_{\text{forest}}$   
 Forest area of a country [ha]  
 N Urban population [persons]

For the study we have made the following assumptions:  $e_{\text{bio}}=0.5 \text{ MWh/ton}$ ,  $w_{\text{mun}}=0.35 \text{ ton/capita/year}$ .

### Hydropower

Hydropower is already used in many MENA countries. Plants range from large multi-Megawatt dams like Aswan to micro-hydropower schemes of several kW capacity. Hydropower is often submitted to seasonal fluctuations and especially in MENA, dry years often lead to hydropower shortages. There are run-of-river plants that provide power according to the available water flow. Dam storage power plants can provide power on demand and can be used to compensate the fluctuations of other renewable energies. In MENA hydropower is used mainly for peaking and intermediate load with 1000 to 4000 full load hours per year. Capacity factors are defined by the individual regional power demand and water resources. The Nile river is the most plentiful hydropower resource of the region. However, there are some indications that the hydropower potentials in the Southern Mediterranean region may be submitted to a reduction of up to 25 % in the course of this century due to climate change /Lehner et al. 2005/. Capacity credit and availability of hydropower plants are considered to be 90 %. Electricity generation from hydropower is well documented and thus taken from literature /WEC 2004/, /Horlacher 2003/.

$$E_{\text{hydro}} = P_{\text{hydro}} \cdot CF_{\text{hydro}} \cdot 8760 \text{ h/y}$$

$E_{\text{hydro}}$  Annual electricity yield from hydropower plants [MWh/y]

$CF_{\text{hydro}}$  Capacity factor (from existing hydropower plants of a country)  $P_{\text{hydro}}$  Installed hydropower capacity [MW] 8760  
 represents the total hours per year

### Concentrating Solar Thermal Power and Solar Chimneys

Concentrating solar thermal power plants with thermal energy storage and fuel co-firing can provide power on demand, with a capacity credit and availability of 90 % like conventional power plants. Electricity generation is a function of their capacity factor which is defined by the demand. The plants are operated in accordance with the rest of the renewable energy mix in order to minimize the gap between the load and the renewable electricity supply.

The electricity yield  $E_{\text{CSP}}$  from solar thermal power plants is calculated with the following equation, taking into consideration the capacity factor that is defined by the load. The solar share is steadily increased and the fossil share reduced, by increasing the solar collector field and storage capacities.

$$E_{\text{CSP}} = P_{\text{CSP}} \cdot CF_{\text{CSP}} \cdot 8760 = E_{\text{solar}} + E_{\text{fossil}}$$

$E_{\text{CSP}}$  Annual electricity yield [MWh/y]

$E_{\text{solar}}$  Annual solar electricity yield [MWh/y]  $E_{\text{fossil}}$  Annual  
 fossil electricity yield [MWh/y]  $CF_{\text{CSP}}$  Capacity factor as



function of load

$P_{CSP}$  Installed capacity [MW]

8760 represents the total hours per year.

Solar chimneys are also considered as solar thermal power plants, though not concentrating. They consist of a very large glass or plastic roof with a chimney in its centre. The air underneath the glass roof is heated and by its lower weight forced into the chimney, where it activates a wind turbine for power generation. They can be built in the range of 100 - 200 MW capacity. Heat can be stored in the soil and in water storage below the collector for night-time operation. They cannot be used for co-generation of electricity and heat. Hybrid operation with fuels is not possible. Their availability and capacity credit is considered 90 %. They are suited for base load and intermediate power. Solar chimney potentials are considered part of the solar thermal power potential and are not quantified separately.

### **Conventional Power**

The MED-CSP study also looks at conventional power technologies as possible alternative or complement to a sustainable energy supply. The availability and capacity credit of all conventional systems is assumed to be 90 %. They provide power on demand with different capacity factors. All thermal plants can be used for co-generation of electricity and heat.

#### ➤ **Oil and Gas fired Power Plants**

Oil and gas can be used in steam cycle, gas turbine or combined cycle power plants. They are built in all capacity classes from several kW to several 100 MW. They can provide peak, intermediate and base load.

#### ➤ **Coal Steam Plants**

Only a few countries in MENA use coal fired steam cycles. Coal must be imported. Capacities range from some 10 to several 100 MW. Due to the long start-up time and the relatively high investment cost, they are only applied in the intermediate and base load segment.

#### ➤ **Nuclear Fission and Fusion**

Nuclear plants use nuclear fission processes to generate steam for steam turbines. There is intensive research on nuclear fusion aiming at providing first results in terms of a first power plant in the year 2050 or beyond. Projected unit sizes are in the GW capacity range. Due to their high investment cost, they are only applied in the base load segment.

## **Renewable Energy Applications**

### **Electricity Generation**

All the technologies investigated within this study can be used for electricity generation. Only biomass, hydropower, geothermal power, solar thermal and conventional power plants can deliver electricity on demand. Photovoltaic systems, micro-hydropower, wind power, biogas motor generators and dish-Stirling engines are specially suited for decentralized and remote electricity generation. In the quantification of market potentials in our scenario we do not distinguish between centralised, grid- connected power and remote systems. Both centralized and decentralized systems have considerable market potentials and will complement each other rather than compete.

### **Combined Generation of Electricity and Heat**

All thermo-electric systems like biomass, geothermal, solar thermal and conventional plants can be used for co-generation of electricity and heat (see Annex 10 for examples).

### **Seawater Desalination**

Electricity can be used for seawater desalination by reverse osmosis, while co-generated heat can be applied to multi-effect, vapour compression and multi-stage flash thermal desalination plants. Also combinations are possible. Thermal seawater desalination uses input steam with a temperature range between 70 – 110 °C.

### **Cooling**

Electricity can be used directly in conventional mechanical compression chillers for air conditioning, cooling and refrigeration. Co-generated heat can be applied to drive vapour absorption chillers. Vapour absorption chillers use input steam with a temperature between 120 – 180 °C. Concentrating solar power has also been directly applied to provide cooling and air conditioning for a Hotel in Turkey.

### **Industrial Process Heat**

Industrial process heat in form of steam or hot air in the temperature range of 50 - 300 °C can be delivered by all thermal systems that are capable of co-generation. It is particularly efficient to cascade the use of heat at different temperature levels.

### **Integrated Systems and Multipurpose Plants**

The collectors of some CSP systems provide shaded areas that could be used for purposes like greenhouse, chicken farm, parking etc. Integrated systems that use power, desalted water and shade for generating a new environment for

farming in desert regions could become feasible in the future as countermeasure to desertification and loss of arable land. This requires more investigation on the possibilities and restrictions of such systems.

### UNIQUE MHD WORKING FLUID

The Solar MHD Generator uses a saturated ionic Ferro fluid in critical (single-phase) state as working medium— that is, an aqueous magnetite (or other diamagnetic material with proper Curie temp) based suspension with some sea salt added. Ionic fluids are known MHD mediums but have not been used commercially; Ferro fluids are unique and are just beginning to see serious research among German MHD scientists. The combination of these fluids creates a truly unique medium. Compared to the two common MHD working mediums, plasma and liquid metal, several issues have been avoided and new properties are available<sup>1</sup>

- 1 - Ferro fluid has two properties that can be exploited in this system: the ability for magneto-caloric pumping and reverse viscosity.

**Magneto-Caloric Pumping** - When the Curie temperature of the Ferro fluid is lower than that of the permanent magnet (in this case the same magnet used in the MHD channel) and sufficient heat is applied to one side of the MHD channel (the Ferro fluid is drawn towards the field but would otherwise stop upon equilibrium of the fluid mass) the Ferro fluid will flow continuously because it has lost its magnetic attraction to the magnet. This is not the primary method of moving the medium; rather, it is a positive side effect of the design.

**Reverse Viscosity** - When Ferro fluid is allowed to flow through a channel subjected to an alternating magnetic field, the boundary layer friction to that inner wall of the channel is significantly reduced. Utilizing this property is simple and not only adds to the efficiency, it (the frequency) can be harmonically coupled to the pulse of the pressure valve and discharge of the capacitor bank.

- 2 - An aqueous medium used in its critical state doesn't require super-heating, which in turn doesn't burn out electrodes as plasma based systems do. The medium maintained in this state or as near to it as possible – will allow an expansion of the fluid to occur without precipitation of the mineral suspension (a problem with the two-phase option which may or may not be negligible depending on several factors). Liquid metal based MHD generators also suffer from viscosity and the necessity to infuse gas for expansion, this makes it even more inefficient

### MID-STAGE TESLA TURBINE

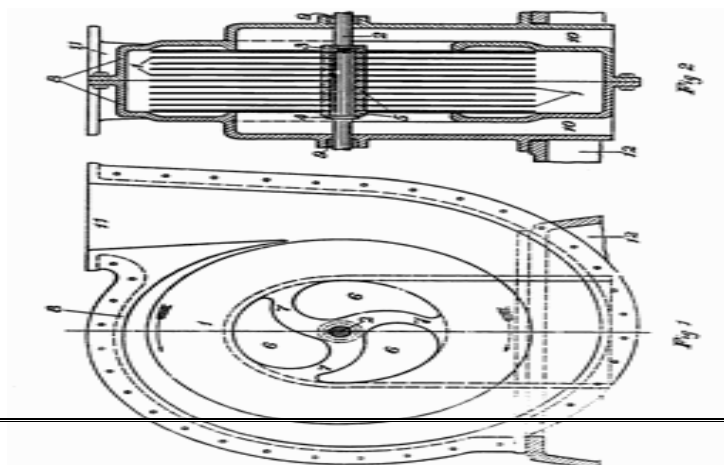

In the 50's and 60's the USSR and US both conducted research on large centralized MHD generators. These were mostly intended for emergency use of 10 to 15 seconds. Even though both countries approached the MHD question (Is this a viable conversion technology?) in different ways the consensus was that even though the conversion is direct and inherently efficient, the designs and methods of the day didn't warrant further development. One attempt to increase efficiency was introducing second-stage turbines to utilize the thrust exiting the MHD channels (generally in open-cycle systems). This is a logical component, as MHD generators are essentially solid-state and adding one rotary element can only add to the output.

One type of turbine – also like the aforementioned to see practically no commercial use but amazingly efficient – is the Tesla Turbine. Simply stated the Tesla Turbine is a turbine in which the blades run parallel to the flow of the medium as opposed to conventional turbines where the blades meet the medium perpendicularly or at an angle. The force of the flowing medium is transferred in a Tesla Turbine therefore, not through direct impact and transfer of inertia but via the boundary layer. The primary advantage is that the freely spiraling flow can impart rotary force without incurring cavitation or any turbulence – it is laminar.

The use of the Tesla Turbine is more than an add-on source of generation; it functions as a heat sink. It is known that an inward spiraling flow of a fluid will cool, order and condense that fluid. This is exactly what the Tesla Turbine does as configured with the hot input along the periphery, and cool output in the perpendicular center. The Tesla Turbine in this design is mid-stage because there are two MHD channels, one before and one after the Turbine.

Interesting note:

In an initial consultation with NYSERDA, and then again with a physicist at Cornell, curiously, I was told not to use a Tesla Turbine. The NYSERDA rep admitted he knew of the claims that the Tesla Turbine was the most efficient rotary engine ever conceived but stated that normal turbines have likely improved beyond the performance of a Tesla Turbine since. The physicist had never heard of a Tesla Turbine and admitted it would be efficient, but said that I shouldn't try to be too innovative and that off-the-shelf turbines would be better.

#### TWIN INTERNAL INDUCTION MHD CHANNELS

Unlike conventional MHD Channels with external horseshoe magnets this design has ring or disk magnets arranged inside the center of the channel. Another major difference is that electricity is not generated via potential across electrodes, it is generated via induction. Ion transfer and direct current is not the goal but simply a varying magnetic

field and perpendicular flow of a conductor across that field. This will be an AC MHD Generator not DC.

Induction and local oscillation on the permanent magnet stack occur via a bifilar coil where one coil is insulated and one is bare. The insulated wire will pulse the designated frequency at a minimal voltage (enough to produce reverse viscosity) and the bare wire will induct a current.

It is the intent, through the use of harmonic capacitor banks and diodes, to recreate the flow and pulsing of the fluid in the electric circuit – that is, to create a self-similarity of the electricity and working fluid within the wires and channels/piping respectively.

The primary purpose of two MHD channels is to provide as much effective surface for induction as possible. Secondly, since one is before the heat source and one is after, they can help regulate temperature of the working fluid. Specifically, Channel 1, (before the heat source) is the Channel that uses the magneto-caloric pumping. As the cool fluid passes over the magnets it generates a current and in turn heats up the induction coil, which in turn adds to the effect and simultaneously preheats the fluid for the critical phase.

Channel 2 (after the heat source) will help pre-cool the fluid when it gives up energy; this makes the Turbine more effective because the fluid is that much denser. Thermoelectric experiments to create the Seebeck and Peltier effects in the channels will be tested too.

### **Solar focus Chamber and critical phase regulation:**

The Solar Focus Chamber is where the sun's rays impart their energy into the generator by thermally exciting the working fluid. It is simply a coil of tubing with the upper length returning back down through the center. It joins below to the MHD channels, and between these two junctions are valves. On the Channel 1 junction, a one-way valve is used. Heat from the coil is allowed to dissipate in heat sink fins for which the valve is also designed – a means of inducing the magneto-caloric pumping effect at the proper point in the channel. On the channel 2 side is a pressure valve. The timing and coordination of this valve with another component is necessary to isolate and harness the critical state. The other governing component is a Fresnel lens and transparent piston mechanism. This will be designed to add pressure to the fluid in the chamber while simultaneously adjusting the focal point of the Fresnel lens so that the critical pressure and temperature are self-regulating relative to the expansion of the fluid.

This is perhaps the most challenging aspect of the overall design and will require independent testing before integration. Initially, independent electronic control and feedback elements will be used in the

pressure valve assembly to determine perfect timing for the pulsing of the system. Once this is determined, a mechanical feedback loop can be designed for self-regulation of pulse (according to sunlight intensity).

Another issue is whether this coil/chamber should be made of glass or copper. If glass the BLACK fluid is directly heated and this is efficient, but since this is where the system may precipitate minerals and salt a pulsed copper pipe may prevent coagulation of the minerals, it may be necessary to go with the copper pipe.

#### PROTOTYPING METHODOLOGY:

As mentioned, the USSR and US took different approaches to their MHD designs. Each method yielded valuable information but lacked what the other had. The Russians built MHD facilities all at once as a whole. The Americans tested components individually before putting them all together.

Today we have the option of CAD/CAM but chemical and magneto-rheological aspects must be investigated before mechanical and electrical components can be tested as a whole. Due to the number of novel conversion processes happening simultaneously, it may or may not be cost effective to simulate some before field tests. Simple thermodynamic analysis of collector dimensions is easy enough but the whole system would be difficult to replicate digitally. I've done all the Tesla-esque, eidetic neuroCAD I can for now. It will take help from specialists and perhaps an Edisonian approach to make it happen. The KISS principle must temper the novelty.

#### Introduction to Fuel Cell technology

Fuel cell is a device that takes fuel as input and produces electricity as output converts chemical energy to electrical energy different from battery - A fuel cell will keep on producing electricity as long as fuel is available. It is a chemical factory which transforms raw material (fuel) into final product (electricity)



General concept of a H<sub>2</sub>-O<sub>2</sub> fuel cell